





## FILOSOFIA

Nella filosofia aziendale di AIARDINI, fabbrica italiana di illuminazione, si pone particolare attenzione non solo a proporre collezioni che risultino di gradimento sul mercato, ma soprattutto al loro livello qualitativo.

Questo è di fondamentale importanza e ragione per la quale vengono utilizzati solo i migliori materiali, come i vetri soffiati veneziani e i cristalli Swarovski. Il processo evolutivo del know-how sviluppatosi in questi anni, ha unito la nostra esperienza artigianale con i migliori studi di architettura, per soddisfare le richieste sempre più esigenti di una clientela, sia residenziale che alberghiera, che pone la sua attenzione alla qualità e alla ricercatezza di un design raffinato, che risulta essere apprezzato in ben cinquanta Paesi del mondo.

## PHILOSOPHY

*Into Aiardini corporate philosophy, an Italian handmade lights manufacturer, attention is paid not only to offer collections being attractive to the market, but also and especially to ensure a very high quality level of its products. This is extremely important and reason why the best materials only are used, such as blown Venetian glass and Swarovski crystals.*

*The evolutionary process of the know-how developed in recent years has combined our experience crafted with the finest architecture studios in order to meet the increasingly demanding needs of both private and hospitality customers focused on the quality and sophistication of a refined design, which has proved to be appreciated in fifty countries in the world.*

## Философия

В корпоративной философии итальянской фабрики освещения ручной работы Aiardini уделяется особое внимание не только востребованности коллекций на рынке, но и высочайшим стандартам качества и индивидуальному подходу к каждому клиенту. Это чрезвычайно важно, поэтому мы используем самые лучшие материалы, например, венецианское стекло и кристаллы Сваровски. Эволюционный процесс ноу-хау, сформировавшийся за последние годы, в сочетании с опытом создания коллекций в сотрудничестве с лучшими архитектурными студиями позволяет соответствовать высоким требованиям как частных клиентов, так и крупных корпоративных заказчиков. Aiardini делает ставку на качество и изысканный дизайн своих изделий, который заслужил признание в пятидесяти странах мира.



## LE NOSTRE COLLEZIONI

our collections

AIARDINI® è un marchio registrato e tutti i modelli sono depositati e protetti per il copyright in ambito internazionale.

*AIARDINI® is a registered trademark, and every its creation is a lodged model protected by copyright.*

*AIARDINI® является зарегистрированным товарным знаком и все модели зарегистрированы и защищены авторскими правами на международном уровне.*

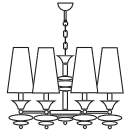

**SCARLETT**  
series | 224

pag  
**8**

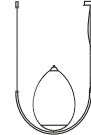

**COCÓ**  
series | 320

pag  
**88**

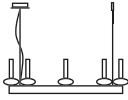

**SHARON**  
series | 226

pag  
**22**



**NINA**  
series | 134

pag  
**98**



**ESMERALDA**  
series | 117

pag  
**28**

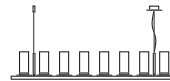

**ROXANNE**  
series | 322

pag  
**108**

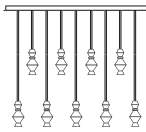

**SELLY**  
series | 330

pag  
**44**



**TANGO**  
series | 110

pag  
**116**

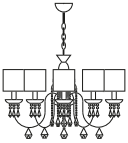

**SOFFIO**  
series | 119

pag  
**48**

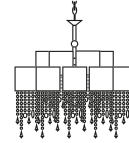

**GLAMOUR**  
series | 123

pag  
**122**

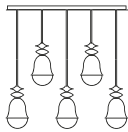

**MARLENE**  
series | 325

pag  
**60**

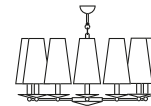

**AMANDA**  
series | 329

pag  
**134**

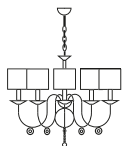

**GABRIEL**  
series | 129

pag  
**68**

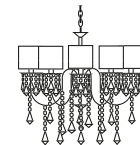

**GIULIETTA**  
series | 203

pag  
**140**



**LISA**  
series | 136

pag  
**80**

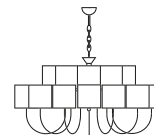

**CAMILLA**  
series | 333

pag  
**146**

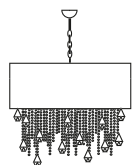

**ALICE**  
series | 135

pag  
**150**

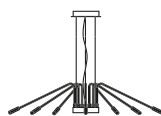

**JOLIE**  
series | 321

pag  
**220**

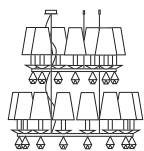

**OTTAGONO**  
series | 100

pag  
**158**

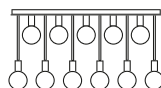

**LOLITA**  
series | 331

pag  
**230**



**METROPOLITAN**  
series | 328

pag  
**166**



**DOMENIQUE**  
series | 323

pag  
**240**

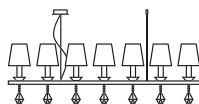

**ELEGANCE**  
series | 126

pag  
**178**

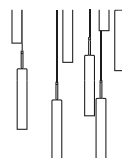

**JAZZ**  
series | 327

pag  
**242**

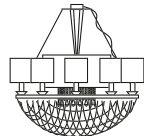

**FLAVIA**  
series | 204

pag  
**190**



**TOGO**  
series | 332

pag  
**244**

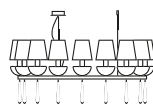

**SINFONIA**  
series | 120

pag  
**198**

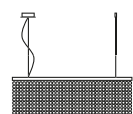

**MELODY**  
series | 133

pag  
**246**



**CHANEL**  
series | 121

pag  
**206**

Personalizzazioni e accessori

pag  
**250**

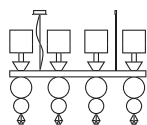

**GINEVRA**  
series | 101

pag  
**210**

index

7  
ALARDINI

224 series

# SCARLETT

la luce di classe Italiana  
*Italian class light*  
Итальянский стиль в свете

Struttura: ottone e parti in metallo  
Diffusori: paralumi troncoconici in tessuto rigido  
Finiture: cromo lucido, oro lucido, oro satinato, nichel satinato, nichel nero,  
rame lucido, rame satinato, bronzo scuro,  
Rosoni a soffitto: in metallo

*Structure: brass and metal parts*  
*Diffusers: truncated cone fabric lampshades*  
*Finishing: polished chrome, polished gold, satin gold, satin nickel, black nickel,*  
*polished copper, satin copper, dark bronze*  
*Ceiling roses: Metal*

Структура: латунь и металлические элементы  
Рассеиватели: оттенки усеченного конуса из плотной ткани  
Отделки: полированный хром, полированное золото, золото сатин, никель сатин  
никель черный, Полированная медь, Матовая медь, Темная бронза,  
Потолочная роза: металл





























224/LP/12L + 6L

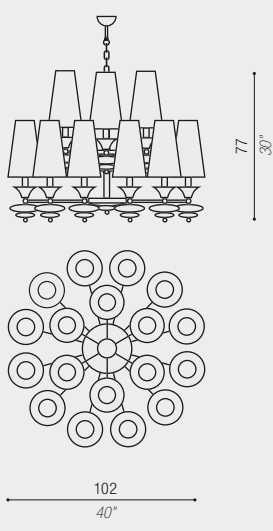

224/LP/12L

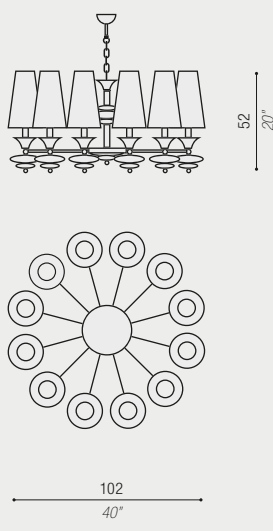

224/LP/10L

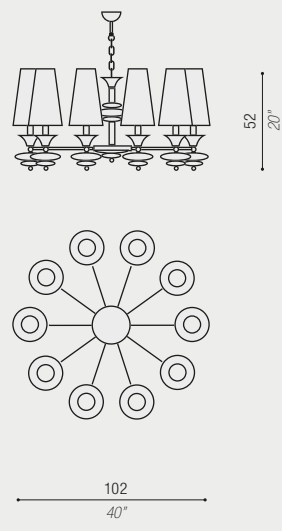

224/LP/8L

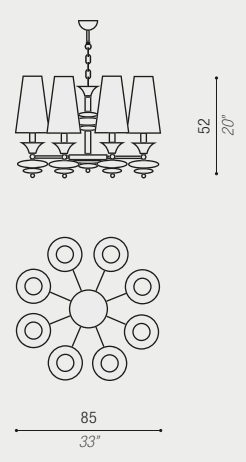

224/LP/6L

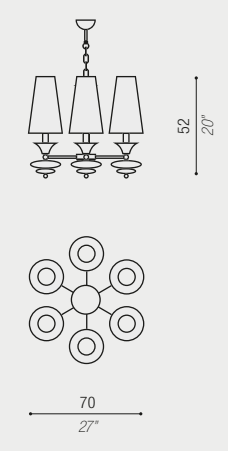

224/SP/3L

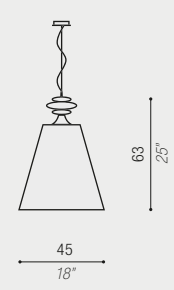

224/AP/2L

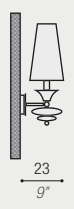

224/AP/1L

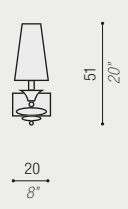

224/LTE/1L

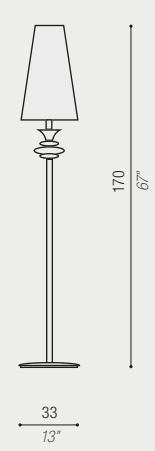

224/LTA/G/1L

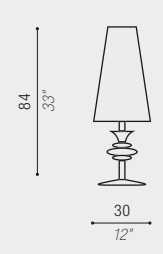

224/LTA/P/1L

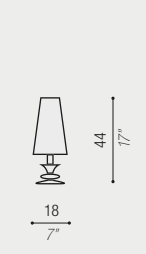

versioni disponibili



legenda a pag. 175

	15 W E27 LED	5 W E14 LED	Europe
	8 W E26 LED	5 W E12 LED	USA & Canada



**NOTE** Le lampadine non sono incluse. Si raccomanda l'uso di prodotti di alta qualità OSRAM o PHILIPS.  
Bulbs are not included. The use of high quality OSRAM or PHILIPS products is recommended.  
Лампочки не включены. Рекомендуется использовать высококачественные продукты OSRAM или PHILIPS.

226 series

# SHARON

puro stile moderno  
*pure modern style*  
Чистый современный стиль

Struttura: ottone e parti in metallo  
Finiture: cromo lucido, oro lucido, oro satinato, nichel satinato  
nichel nero, rame lucido, rame satinato, bronzo scuro, bianco  
Rosoni a soffitto: in metallo

*Structure: brass and metal parts*  
*Finishing: polished chrome, polished gold, satin gold, satin nickel,*  
*black nichel, polished copper, satin copper, dark bronze, white*  
*Ceiling roses: Metal*

Структура: латунь и металлические элементы  
Отделки: полированный хром, полированное золото, золото сатин,  
никель сатин никель черный, Полированная медь, Матовая медь,  
Темная бронза, Белый  
Потолочная роза: металл













226/SP/12L + 6L

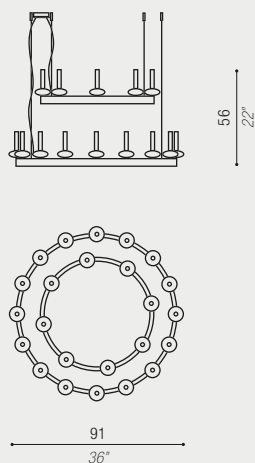

226/SP/16L

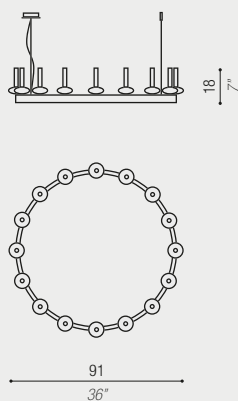

226/SP/8L

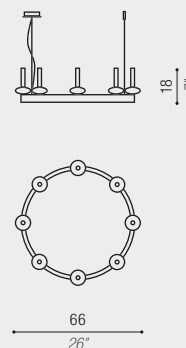

226/LTA/1L



226/AP/1L

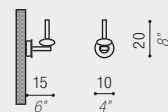

versioni disponibili



legenda a pag. 175



bi-spina  
G9 led

Europe

USA &  
Canada



**NOTE** Le lampadine non sono incluse. Si raccomanda l'uso di prodotti di alta qualità OSRAM o PHILIPS.

Bulbs are not included. The use of high quality OSRAM or PHILIPS products is recommended.

Лампочки не включены. Рекомендуется использовать высококачественные продукты OSRAM или PHILIPS.

117 series

# ESMERALDA

la Vanità, debolezza irresistibile!

*vanity, irresistible weakness!*

Тщеславие - соблазн, перед которым трудно устоять!

Struttura: ottone e parti in metallo

Diffusori: paralumi cilindrici in tessuto rigido

Decorazioni pendenti: catene di cristalli, con anelli in ottone

Finiture: cromo lucido, oro lucido, oro satinato, nichel satinato

Rosoni a soffitto: in metallo

*Structure: brass and metal parts*

*Diffusers: cylindrical fabric lampshades drive*

*Decorations hanging chains of crystals, with brass rings*

*Finishing: polished chrome, polished gold, satin gold, satin nickel*

*Ceiling roses: Metal*

Структура: металл и детали из латуни

Рассеиватели: цилиндрические абажуры из плотной ткани

Подвески: цепочки с кристаллами и кольцами из латуни

Отделки: полированный хром, полированное золото, золото сатин, никель сатин

Потолочная роза: металл















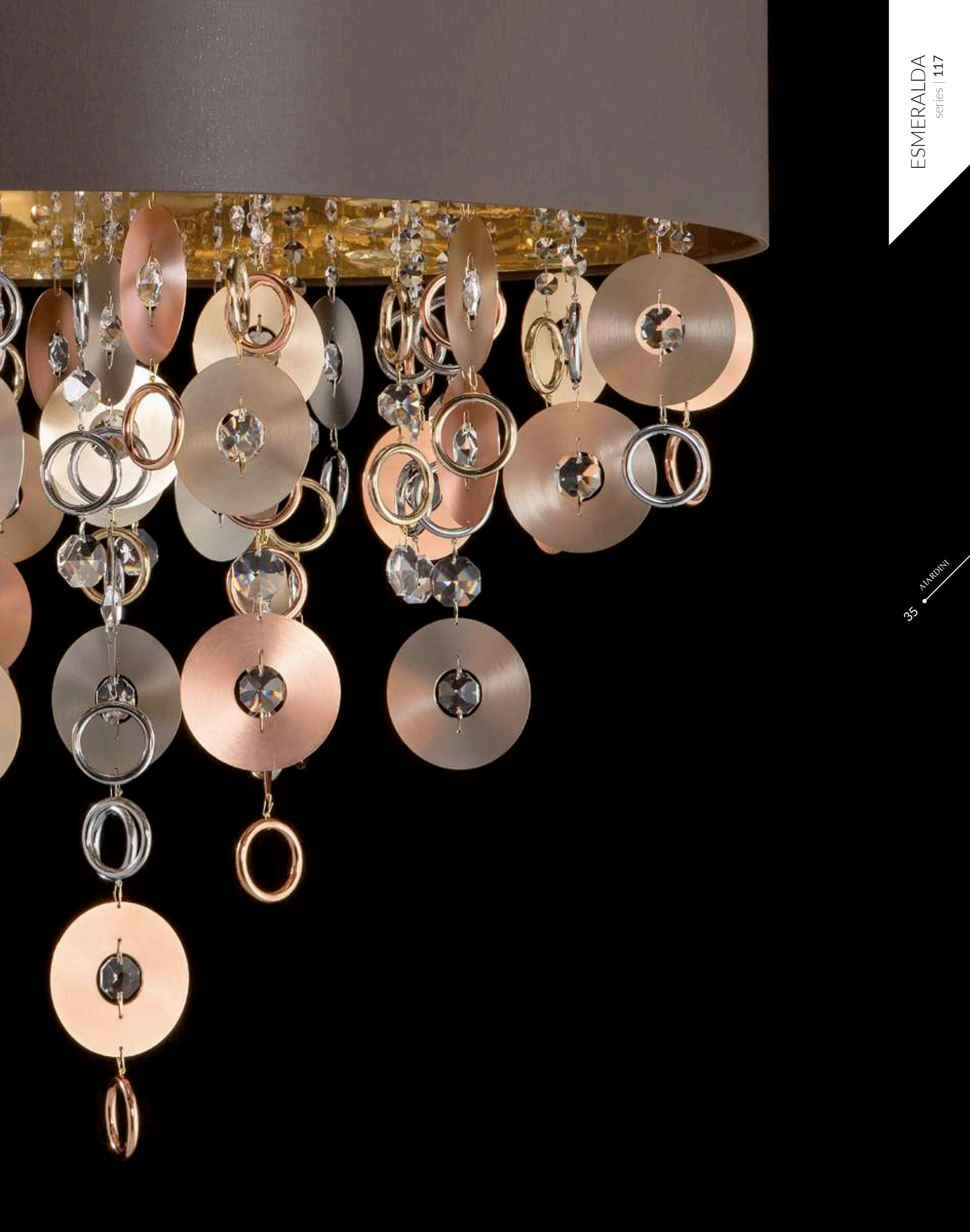

















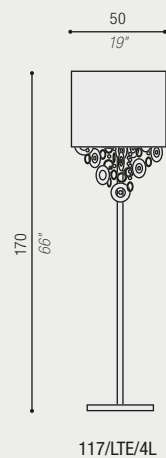
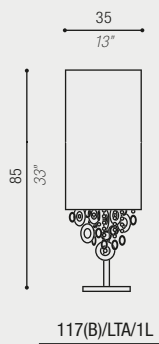
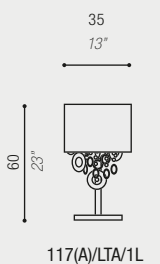
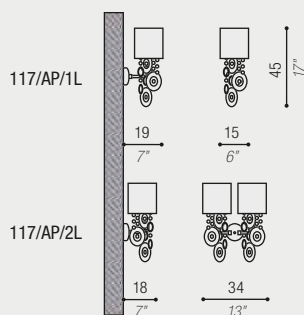
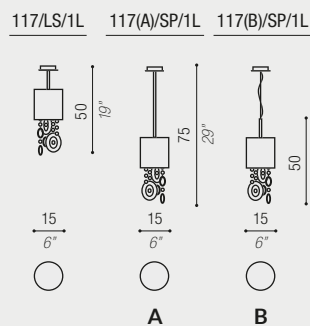
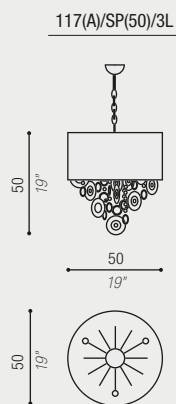
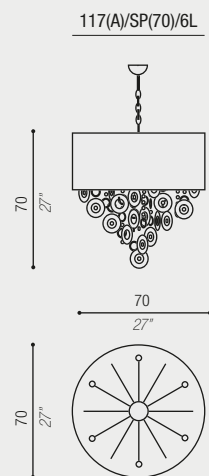
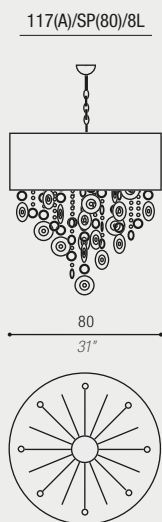
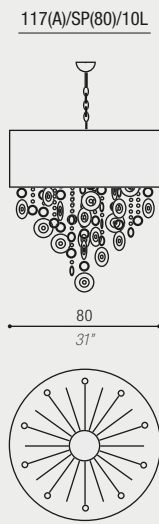
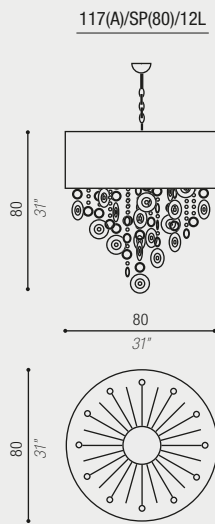
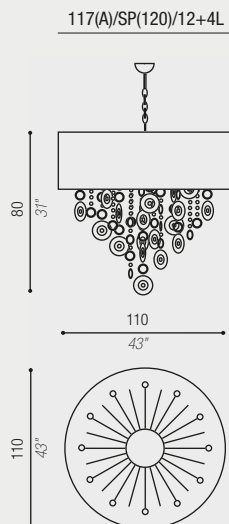

versioni disponibili



legenda a pag. 175



**NOTE** Le lampadine non sono incluse. Si raccomanda l'uso di prodotti di alta qualità OSRAM o PHILIPS.  
Bulbs are not included. The use of high quality OSRAM or PHILIPS products is recommended.  
Лампочки не включены. Рекомендуется использовать высококачественные продукты OSRAM или PHILIPS.

330 series

# SELLY

emozioni essenziali  
*essential emotions*  
Необходимые эмоции

Struttura: ottone e parti in metallo  
Decorazioni: inserto in cristallo sfaccettato  
Finiture: cromo lucido, oro lucido, oro satinato, nichel satinato,  
nichel nero, rame lucido, rame satinato, bronzo scuro, bianco  
Rosoni a soffitto: in metallo

*Structure: brass and metal parts*  
*Decorations: faceted crystal insert*  
*Finishing: polished chrome, polished gold, satin gold, satin nickel*  
*blach nichel, polished copper, satin copper, dark bronze, white*  
*Ceiling roses: Metal*

Структура: латунь и металлические элементы  
Украшение: граненая хрустальная вставка  
Отделки: полированный хром, полированное золото, золото сатин,  
никель сатин никель черный, Полированная медь, Матовая медь,  
Темная бронза, Белый  
Потолочная роза: металл





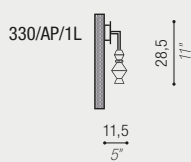
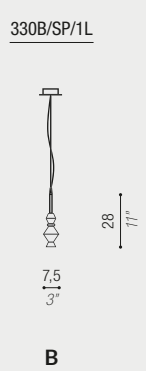
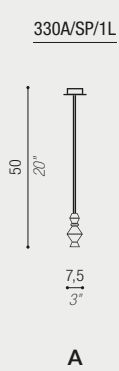
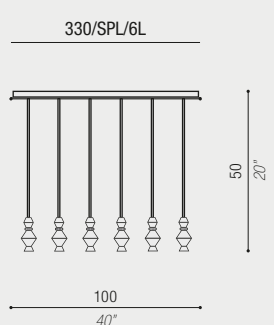
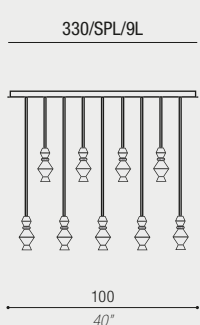

versioni disponibili



legenda a pag. 175



**NOTE** Le lampadine non sono incluse. Si raccomanda l'uso di prodotti di alta qualità OSRAM o PHILIPS.  
 Bulbs are not included. The use of high quality OSRAM or PHILIPS products is recommended.  
 Лампочки не включены. Рекомендуется использовать высококачественные продукты OSRAM или PHILIPS.

119 series

# SOFFIO

soffiatori di vetro... la forza di una cultura italiana!  
*glassblowers, the strength of Italian culture!*

**мастера-стеклодувы - сила итальянской культуры!**

Struttura: ottone e parti in metallo  
Diffusori: paralumi cilindrici in tessuto  
Fusto e Bobeches: in vetro soffiato trasparente Veneziano  
Braccetti: in metallo  
Decorazioni pendenti: in cristallo  
Finiture: cromo lucido, oro lucido, oro satinato, nichel satinato  
Rosoni a soffitto: in metallo

*Structure: brass and metal parts  
Diffusers: white cylindrical fabric lampshades  
Stem and Bobeches: transparent blown glass, Venetian  
Arms: Metal  
Pendants decorations: in crystal  
Finishing: polished chrome, polished gold, satin gold, satin nickel  
Ceiling roses: Metal*

Структура: латунь и металлические элементы  
Рассеиватели: цилиндрические абажуры из ткани  
Остов и розетки: прозрачное венецианское выдувное стекло  
Рожки: металл  
Подвески: кристаллы  
Отделки: полированный хром, полированное золото, золото сатин, никель сатин  
Потолочная роза: металл

















SOFFIO  
series | 119

55  
MARDINI







SOFFIO  
series | 119

57  
MARDINI



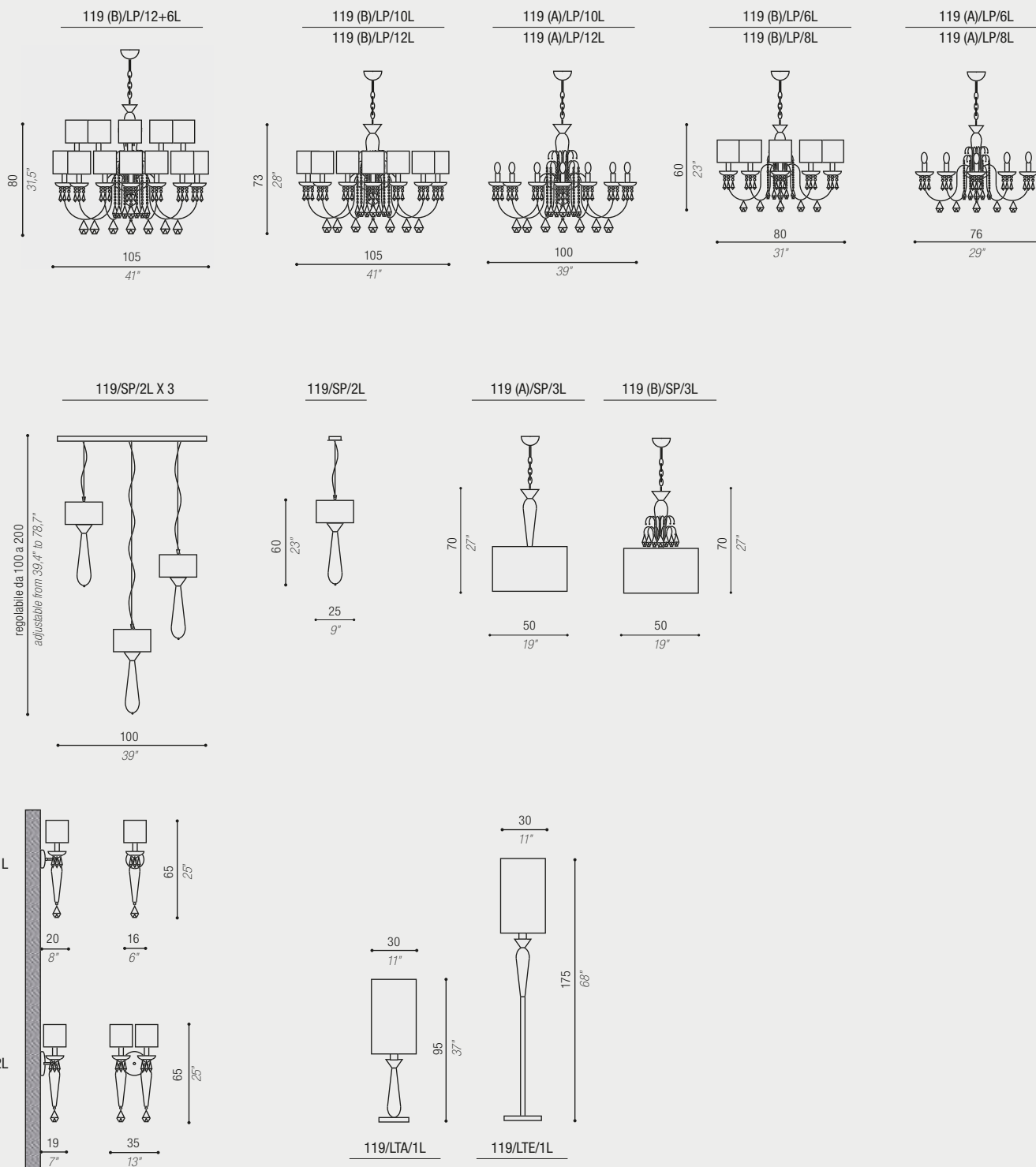

versioni disponibili



legenda a pag. 175



15 W E27 LED  
5 W E14 LED

Europe

8 W E26 LED  
5 W E12 LED

USA & Canada



**NOTE** Le lampadine non sono incluse. Si raccomanda l'uso di prodotti di alta qualità OSRAM o PHILIPS.

Bulbs are not included. The use of high quality OSRAM or PHILIPS products is recommended.

Лампочки не включены. Рекомендуется использовать высококачественные продукты OSRAM или PHILIPS.

325 series

# MARLENE

eleganza minimale  
*minimal elegance*  
Минимальная элегантность

Struttura: ottone e parti in metallo

Finiture: cromo lucido, oro lucido, oro satinato, nichel satinato nichel nero, rame lucido, rame satinato, bronzo scuro, bianco

Rosoni a soffitto: in metallo

*Structure: brass and metal parts*

*Finishing: polished chrome, polished gold, satin gold, satin nickel, black nichel, polished copper, satin copper, dark bronze, white*

*Ceiling roses: Metal*

Структура: латунь и металлические элементы

Отделки: полированный хром, полированное золото, золото сатин, никель сатин никель черный, Полированная медь, Матовая медь, Темная бронза, Белый

Потолочная роза: металл











MARLENE  
series | 325



65  
ALARDINI





129 series

# GABRIEL

vivere brillantemente, un sogno possibile!

*live brilliantly, a possible dream!*

**яркая жизнь, воплощающая мечты!**

Struttura: ottone e parti in metallo  
Diffusori: paralumi cilindrici in tessuto bianco  
Bobeches: cristallo trasparente  
Decorazioni pendenti: sfere sfaccettate in cristallo Swarovski  
Finiture: cromo lucido, oro lucido, oro satinato, nichel satinato  
Rosoni a soffitto: in metallo

*Structure: brass and metal parts  
Diffusers: white cylindrical fabric lampshades  
Bobeches: transparent crystal  
Pendants decorations: faceted crystal balls Swarovski  
Finishing: polished chrome, polished gold, satin gold, satin nickel  
Ceiling roses: Metal*

Структура: латунь и металлические элементы  
Рассеиватели: цилиндрические абажуры из белой ткани  
Розетки: прозрачный хрусталь  
Подвески: стеклянные бусины и граненые кристаллы каплевидной формы  
Отделки: полированный хром, полированное золото, золото сатин, никель сатин  
Потолочная роза: металл





















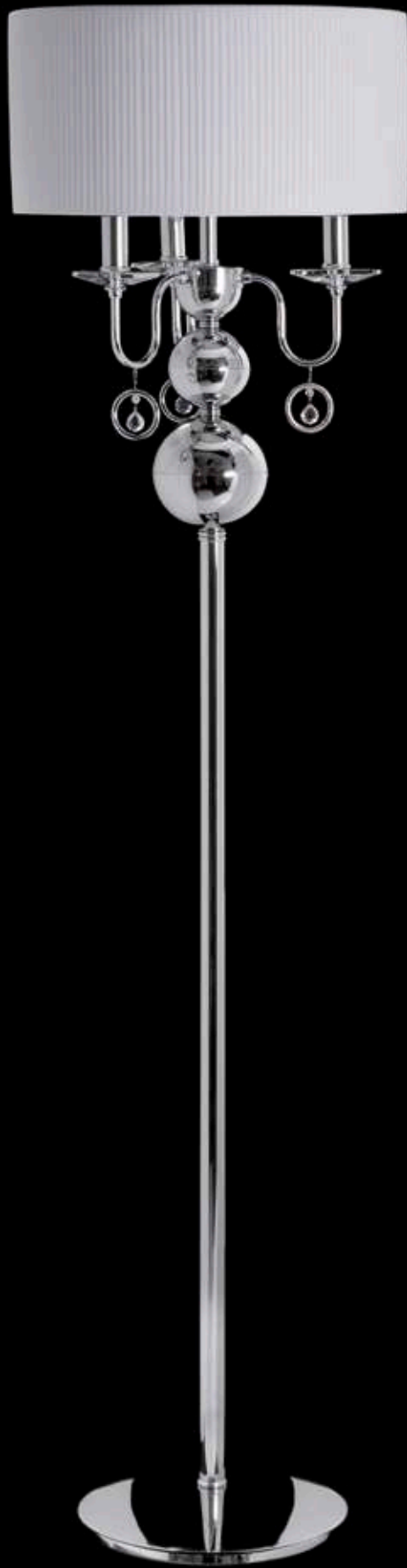

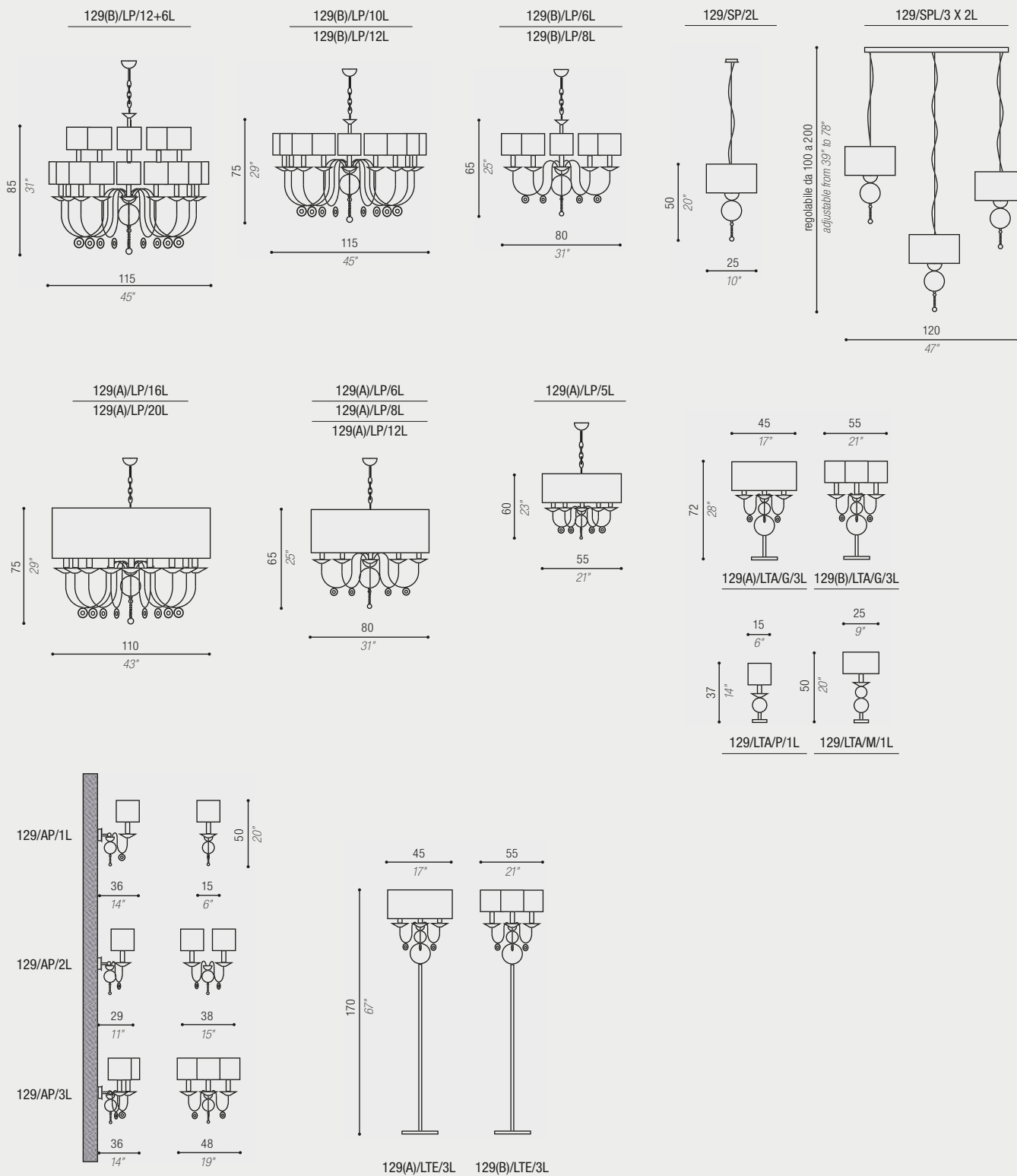

versioni disponibili



legenda a pag. 175

5 W E14 LED Europe  
5 W E12 LED USA & Canada



**NOTE** Le lampadine non sono incluse. Si raccomanda l'uso di prodotti di alta qualità OSRAM o PHILIPS.

Bulbs are not included. The use of high quality OSRAM or PHILIPS products is recommended.

Лампочки не включены. Рекомендуется использовать высококачественные продукты OSRAM или PHILIPS.

136 series

# LISA

una pioggia di cristallo, grandi emozioni!  
*a shower of crystal, great emotions!*

**Впечатляющий дождь из кристаллов**

Struttura: ottone e parti in metallo

Diffusori: paralumi cilindrici in tessuto rigido

Decorazioni pendenti: catene di cristalli, con anelli in ottone

Finiture: cromo lucido, oro lucido, oro satinato, nichel satinato

Rosoni a soffitto: in metallo

*Structure: brass and metal parts*

*Diffusers: cylindrical fabric lampshades drive*

*Decorations hanging chains of crystals, with brass rings*

*Finishes: polished chrome, polished gold, satin gold, satin nickel*

*Ceiling roses: Metal*

Структура: латунь и металлические элементы

Рассеиватели: цилиндрические абажуры из плотной ткани

Декор: подвески из кристаллов с кольцами из латуни

Отделки: полированный хром, полированное золото, золото сатин, никель сатин

Потолочная роза: металл















136(B)/SP(80)/12L  
136(B)/SP(80)/10L  
136(B)/SP(80)/8L

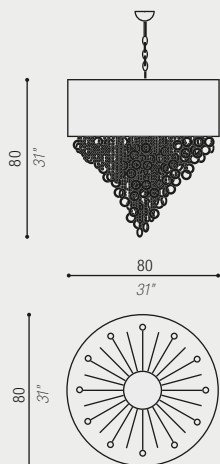

136(B)/SP(70)/6L

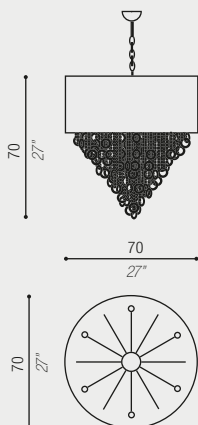

136(B)/SP(50)/3L

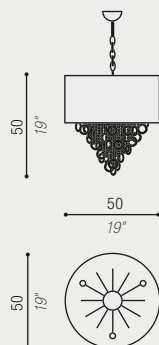

136(C)/SP(85)/12L  
136(C)/SP(85)/10L  
136(C)/SP(85)/8L

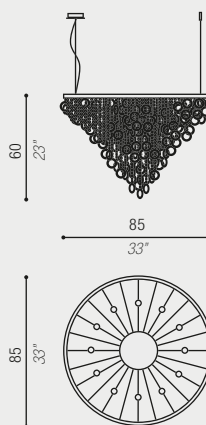

136(C)/SP(60)/6L

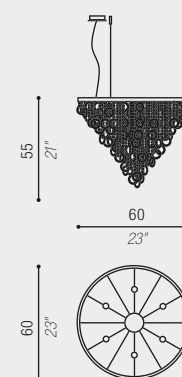

136(A)/SP/12L + 4L  
136(A)/SP/10L + 4L  
136(A)/SP/8L + 4L

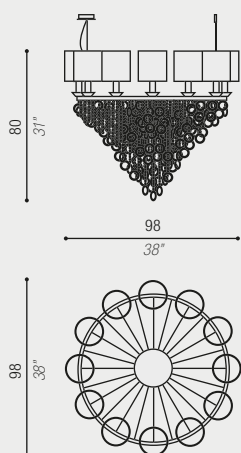

136(A)/SP/6L + 3L

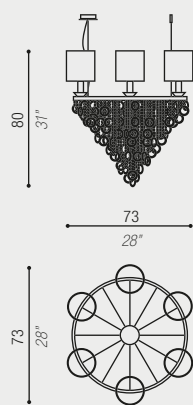

136/AP/3L

136/AP/2L

136/AP/1L

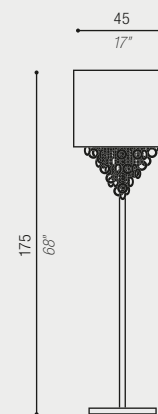
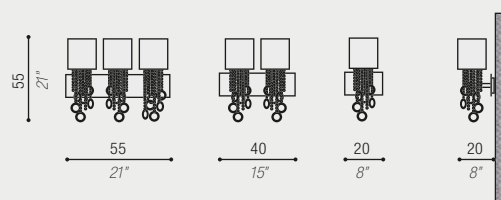

136/LTE/4L

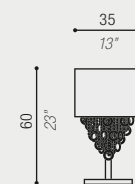

136/LTA/1L

Il modello è disponibile anche nella versione con la cascata di cristalli prolungata fino ad 1 metro.  
The item is also available in a prolonged version with crystal pendants up to 1 meter.  
модель доступна также в версии с удлиненными подвесами - до 1 метра.

versioni disponibili



legenda a pag. 175



**NOTE** Le lampadine non sono incluse. Si raccomanda l'uso di prodotti di alta qualità OSRAM o PHILIPS.

Bulbs are not included. The use of high quality OSRAM or PHILIPS products is recommended.

Лампочки не включены. Рекомендуется использовать высококачественные продукты OSRAM или PHILIPS.

320 series

## COCÓ

amore e passione per il vetro  
*love and passion for glass*  
любовь и страсть к стеклу

Struttura: ottone e parti in metallo

Diffusori: vetro soffiato bianco lucido, lavorato a mano a Venezia

Finiture: cromo lucido, oro lucido, oro satinato, nichel satinato, nichel nero, rame lucido, rame satinato, bronzo scuro, bianco

Rosoni a soffitto: in metallo

*Structure: brass and metal parts*

*Diffuser: blown glass hand made in Venice Pendants*

*Finishing: polished chrome, polished gold, satin gold, satin nickel, black nichel, polished copper, satin copper, dark bronze, white*

*Ceiling roses: Metal*

Структура: латунь и металлические элементы

Рассеиватель: венецианское стекло ремесленного выдува

Отделки: полированный хром, полированное золото, золото сатин, никель сатин никель черный, Полированная медь, Матовая медь

Темная бронза, Белый

Потолочная роза: металл











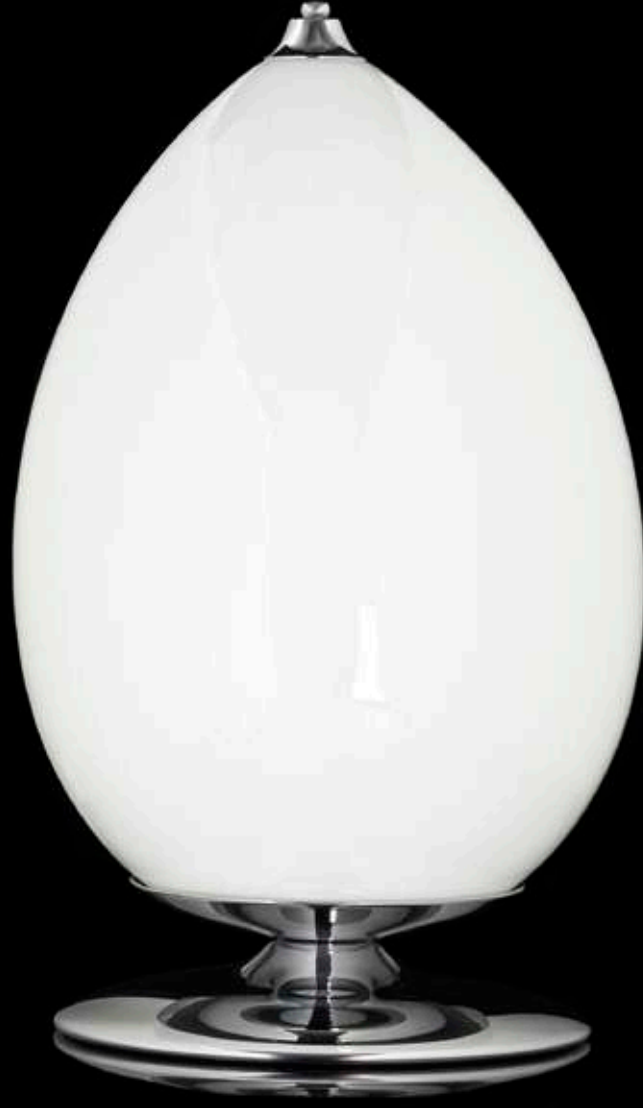





Diffusori: vetro soffiato fumè trasparente, lavorato a mano a Venezia  
Diffuser: transparent smoke glass hand made in Venice  
Рассеиватель: прозрачное дымовое стекло





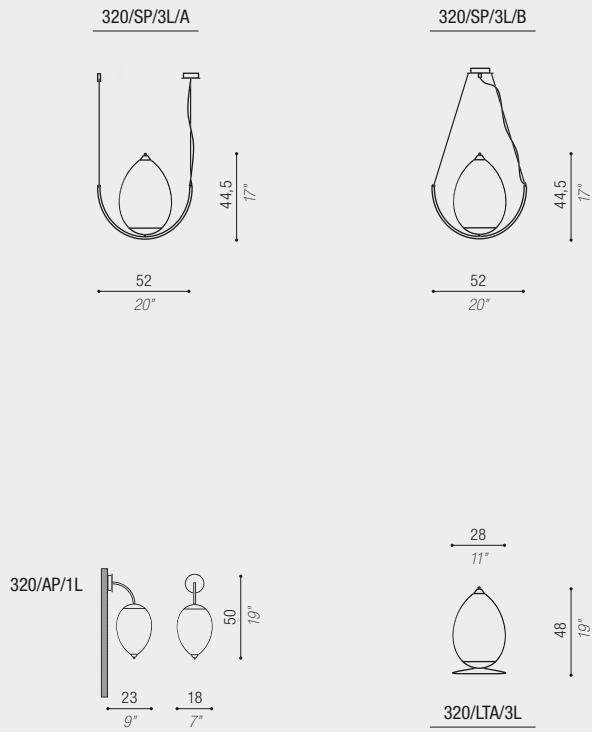

versioni disponibili



legenda a pag. 175



5 W  
E14 LED Europe

---

5 W  
E12 LED USA & Canada



**NOTE** Le lampadine non sono incluse. Si raccomanda l'uso di prodotti di alta qualità OSRAM o PHILIPS.

Bulbs are not included. The use of high quality OSRAM or PHILIPS products is recommended.

Лампочки не включены. Рекомендуется использовать высококачественные продукты OSRAM или PHILIPS.

134 series

## NINA

il linguaggio emozionale della luce!  
*the emotional language of light!*

**ЭМОЦИОНАЛЬНЫЙ ЯЗЫК СВЕТА!**

Struttura: ottone e parti in metallo

Diffusori: paralumi troncoconici in tessuto rigido

Decorazioni pendenti: catene di cristalli, con anelli in ottone

Finiture : cromo lucido, oro lucido, oro satinato, nichel satinato

Rosoni a soffitto: in metallo

*Structure: brass and metal parts*

*Diffusers: cylindrical fabric lampshades drive*

*Decorations hanging: chains of crystals, with brass rings*

*Finishing: polished chrome, polished gold, satin gold, satin nickel*

*Ceiling roses: Metal*

Структура: металл и детали из латуни

Рассеиватели: абажуры в форме усеченного конуса из плотной ткани

Розетки: прозрачный хрусталь

Декор: цепочки кристаллов с кольцами из латуни

Отделки: полированный хром, полированное золото, золото сатин, никель сатин

Потолочная роза: металл



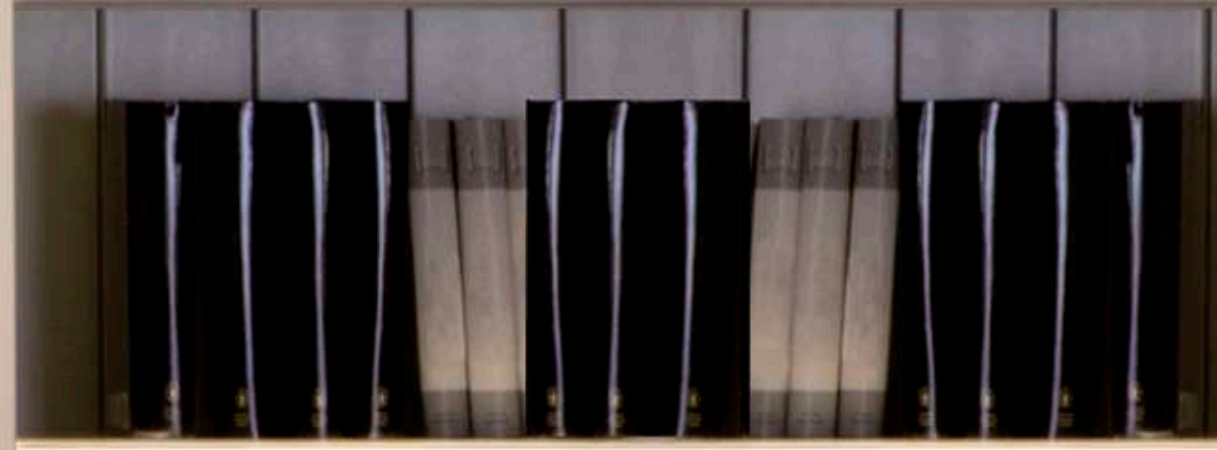













MARRINI  
MADE IN ITALY



134/LP/12L + 6L

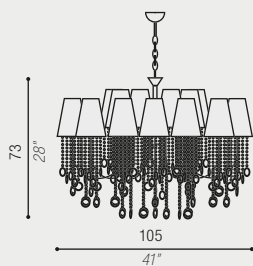

134/LP/10L  
134/LP/12L

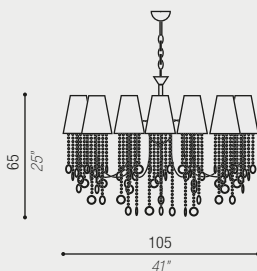

134/LP/6L  
134/LP/8L

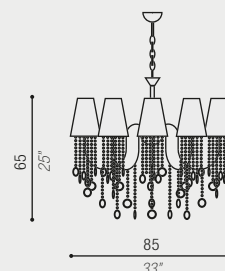

134/SP(50 UP)/4L

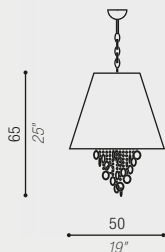

134/SP(16 DOWN)/1L X 5

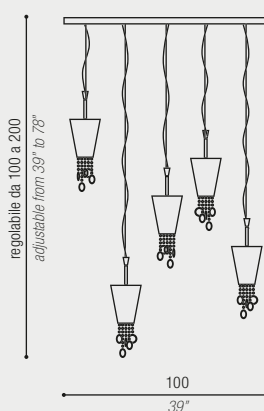

134/SP(16 UP)/1L

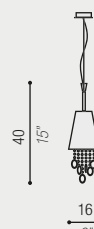

134/SP(16 DOWN)/1L



134/AP/1L

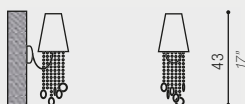

134/AP/2L

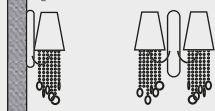

134/AP/3L

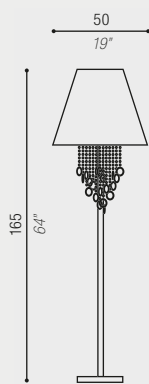
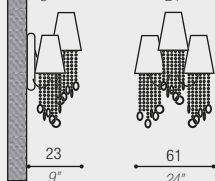

134/LTE (UP)/4L



134/LTA/G/1L

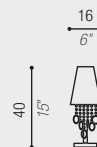

134/LTA/P/1L

versioni disponibili



legenda a pag. 175



15 W E27 LED  
5 W E14 LED  
8 W E26 LED  
5 W E12 LED

Europe

USA & Canada



**NOTE** Le lampadine non sono incluse. Si raccomanda l'uso di prodotti di alta qualità OSRAM o PHILIPS.

Bulbs are not included. The use of high quality OSRAM or PHILIPS products is recommended.

Лампочки не включены. Рекомендуется использовать высококачественные продукты OSRAM или PHILIPS.



322 series

# ROXANNE

passioni di luce  
*passions of light*  
Страсть света

Struttura: ottone e parti in metallo  
Diffusori: vetro soffiato bianco lucido, lavorato a mano a Venezia  
Finiture: cromo lucido, oro lucido, oro satinato, nichel satinato, nichel nero, rame lucido, rame satinato, bronzo scuro, bianco  
Rosoni a soffitto: in metallo

*Structure: brass and metal parts  
Diffuser: blown glass hand made in Venice Pendants  
Finishing: polished chrome, polished gold, satin gold, satin nickel, black nichel, polished copper, satin copper, dark bronze, white  
Ceiling roses: Metal*

Структура: латунь и металлические элементы  
Рассеиватель: венецианское стекло ремесленного выдува  
Отделки: полированный хром, полированное золото, золото сатин, никель сатин никель черный, Полированная медь, Матовая медь, Темная бронза, Белый  
Потолочная роза: металл













## DISPONIBILITÀ COLORI VETRO

---

*GLASS COLORS AVAILABILITY*  
НАЛИЧИЕ СТЕКЛЯННЫХ ЦВЕТОВ

**vetro trasparente fumè**

*transparent smoke glass*  
прозрачное дымовое  
стекло

**vetro trasparente**

*transparent glass*  
прозрачное стекло

**vetro bianco latte**

*white milk glass*  
белый молочный  
стакан



322/SPL/8L

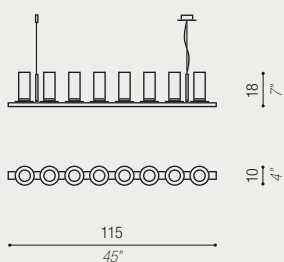

322/SP/4L

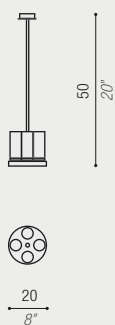

322/LTA/1L



322/LTA/4L



322/AP/8L

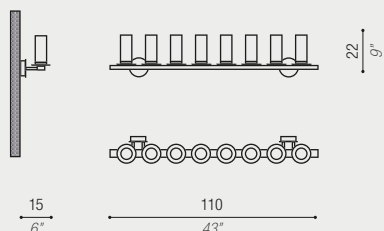

322/AP/4L

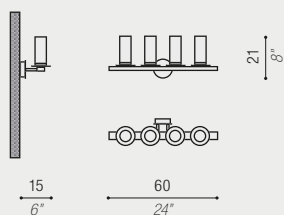

322/AP/1L

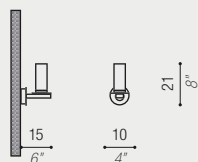

versioni disponibili



legenda a pag. 175



5 W  
E14 LED Europe  
5 W  
E12 LED USA & Canada



**NOTE** Le lampadine non sono incluse. Si raccomanda l'uso di prodotti di alta qualità OSRAM o PHILIPS.

Bulbs are not included. The use of high quality OSRAM or PHILIPS products is recommended.

Лампочки не включены. Рекомендуется использовать высококачественные продукты OSRAM или PHILIPS.

110 series

# TANGO

una luce piena d'idee!  
*a full light of ideas!*  
Свет, полный идей!

Struttura: ottone e parti in metallo, cucitura realizzata interamente a mano  
Diffusori: vetro soffiato fumè trasparente, lavorato a mano a Venezia  
Decorazioni pendenti: gocce di vetro lavorate a mano a Venezia disponibili in bianco, nero oppure ambra

*Structure: brass and metal parts, sewing entirely made by hand*  
*Diffuser: transparent smoke glass hand made in Venice*  
*Pendants decorations: venetian glass drops (white, black or amber)*  
*Finishing: polished chrome or gold*

Структура: латунь и металлические элементы, плетеная часть сделана вручную  
Рассеиватель: прозрачное дымовое стекло ручной работы в Венеции  
Декор: капли из венецианского стекла в черной, белой или янтарной версиях  
Отделки: полированный хром или полированное золото











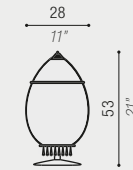
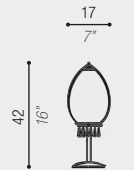
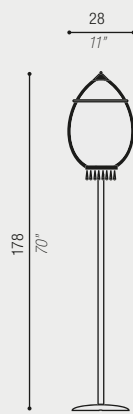
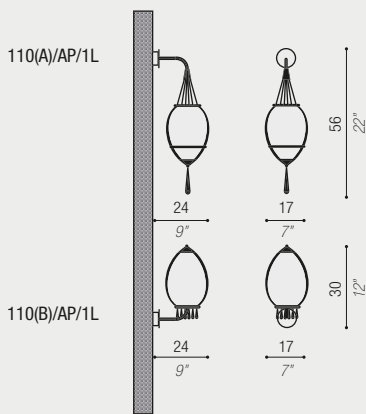
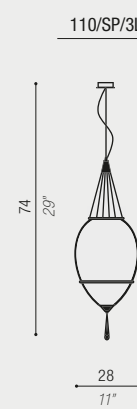
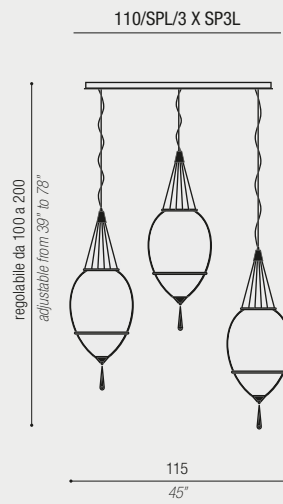
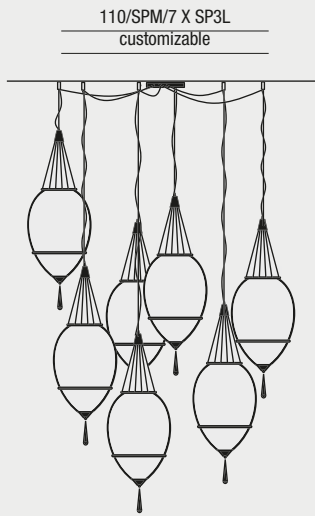

versioni disponibili



legenda a pag. 175

	15 W E27 LED	5 W E14 LED	Europe
	8 W E26 LED	5 W E12 LED	USA & Canada



**NOTE** Le lampadine non sono incluse. Si raccomanda l'uso di prodotti di alta qualità OSRAM o PHILIPS.

Bulbs are not included. The use of high quality OSRAM or PHILIPS products is recommended.

Лампочки не включены. Рекомендуется использовать высококачественные продукты OSRAM или PHILIPS.

123 series

# GLAMOUR

il fascino e l'eleganza del cristallo, con i pendagli veneziani  
*the charm and elegance of crystal, with the venetian pendants*  
шарм и элегантность кристаллов и венецианских подвесок!

Struttura: ottone e parti in metallo

Diffusori: paralumi cilindrici in tessuto rigido

Decorazioni pendenti: tondo realizzato con catene pendenti in cristallo e gocce di vetro veneziano.

Finiture: cromo lucido, oro lucido, oro satinato, nichel satinato

Rosoni a soffitto: in metallo

*Structure: brass and metal parts*

*Diffusers: cylindrical fabric lampshades*

*Decorations pendants: round made by crystal pendants chains and venetian glass drops*

*Finishing: polished chrome, polished gold, satin gold, satin nickel*

*Ceiling roses: metal*

Структура: металл и детали из латуни

Рассеиватели: цилиндрические абажуры из плотной ткани

Декор: цепочки из кристаллов и капель из венецианского стекла, развешенные по кругу

Отделки: полированный хром, полированное золото, золото сатин, никель сатин

Потолочная роза: металл























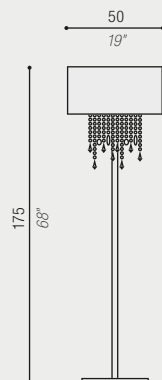
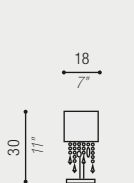
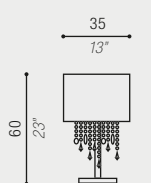
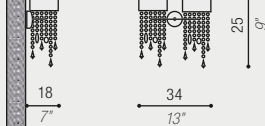
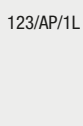
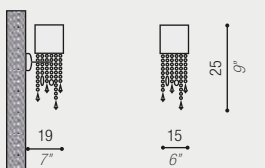
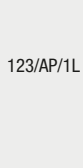
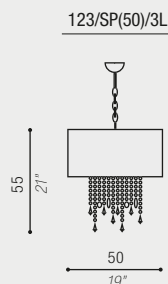
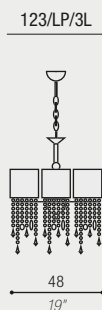
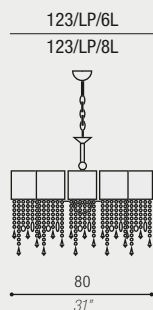
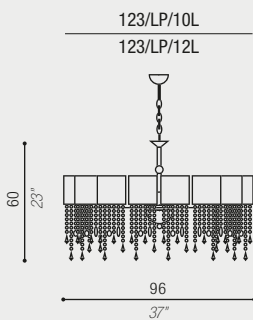
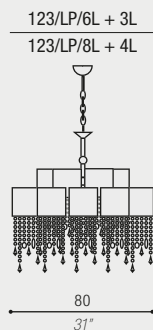
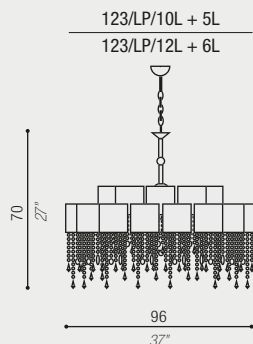

versioni disponibili



legenda a pag. 175



15 W E27 LED 5 W E14 LED

Europe

8 W E26 LED 5 W E12 LED

USA & Canada



**NOTE** Le lampadine non sono incluse. Si raccomanda l'uso di prodotti di alta qualità OSRAM o PHILIPS.

Bulbs are not included. The use of high quality OSRAM or PHILIPS products is recommended.

Лампочки не включены. Рекомендуется использовать высококачественные продукты OSRAM или PHILIPS.

329 series

# AMANDA

stile italiano nel mondo  
*Italian style in the world*  
Итальянский стиль в мире

Struttura: ottone e parti in metallo  
Diffusori: paralumi troncoconici in tessuto rigido  
Finiture: cromo lucido, oro lucido, oro satinato, nichel satinato,  
nichel nero, rame lucido, rame satinato, bronzo scuro, bianco  
Rosoni a soffitto: in metallo

*Structure: brass and metal parts*  
*Diffusers: truncated cone fabric lampshades*  
*Finishing: polished chrome, polished gold, satin gold, satin nickel,*  
*black nickel, polished copper, satin copper, dark bronze, white*  
*Ceiling roses: Metal*

Структура: латунь и металлические элементы  
Рассеиватели: оттенки усеченного конуса из плотной ткани.  
Отделки: полированный хром, полированное золото, золото сатин,  
никель сатин никель черный, Полированная медь, Матовая медь  
Темная бронза, Белый  
Потолочная роза: металл











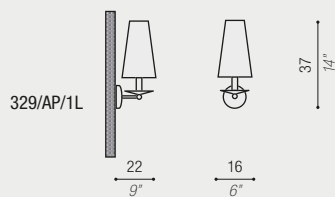
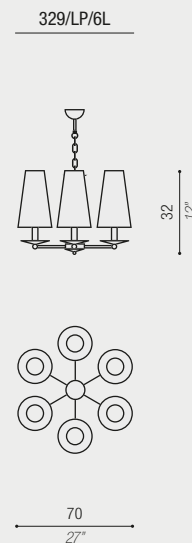
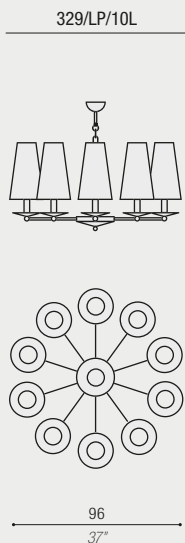
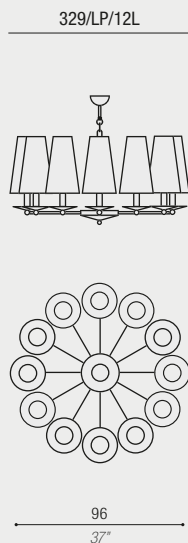

versioni disponibili



legenda a pag. 175



5 W  
E14 LED

Europe

5 W  
E12 LED

USA &  
Canada



**NOTE** Le lampadine non sono incluse. Si raccomanda l'uso di prodotti di alta qualità OSRAM o PHILIPS.

Bulbs are not included. The use of high quality OSRAM or PHILIPS products is recommended.

Лампочки не включены. Рекомендуется использовать высококачественные продукты OSRAM или PHILIPS.

203 series

# GIULIETTA

Idee italiane, uno stile di vita!

*Italian ideas, a lifestyle!*

**Итальянские идеи – стиль жизни!**

Struttura: ottone e parti in metallo

Diffusori: paralumi cilindrici in tessuto rigido

Decorazioni pendenti: catene di cristallo

Finiture : cromo lucido, oro lucido, oro satinato, nichel satinato

Rosoni a soffitto: in metallo

*Structure: brass and metal parts*

*Diffusers: cylindrical fabric lampshades drive*

*Decorations pendants: crystal chains*

*Finishing: polished chrome, polished gold, satin gold, satin nickel*

*Ceiling roses: Metal*

Структура: металл и детали из латуни

Рассеиватели: цилиндрические абажуры из плотной ткани

Подвески: цепочки кристаллов

Отделки: полированный хром, полированное золото, золото сатин, никель сатин

Потолочная роза: металл











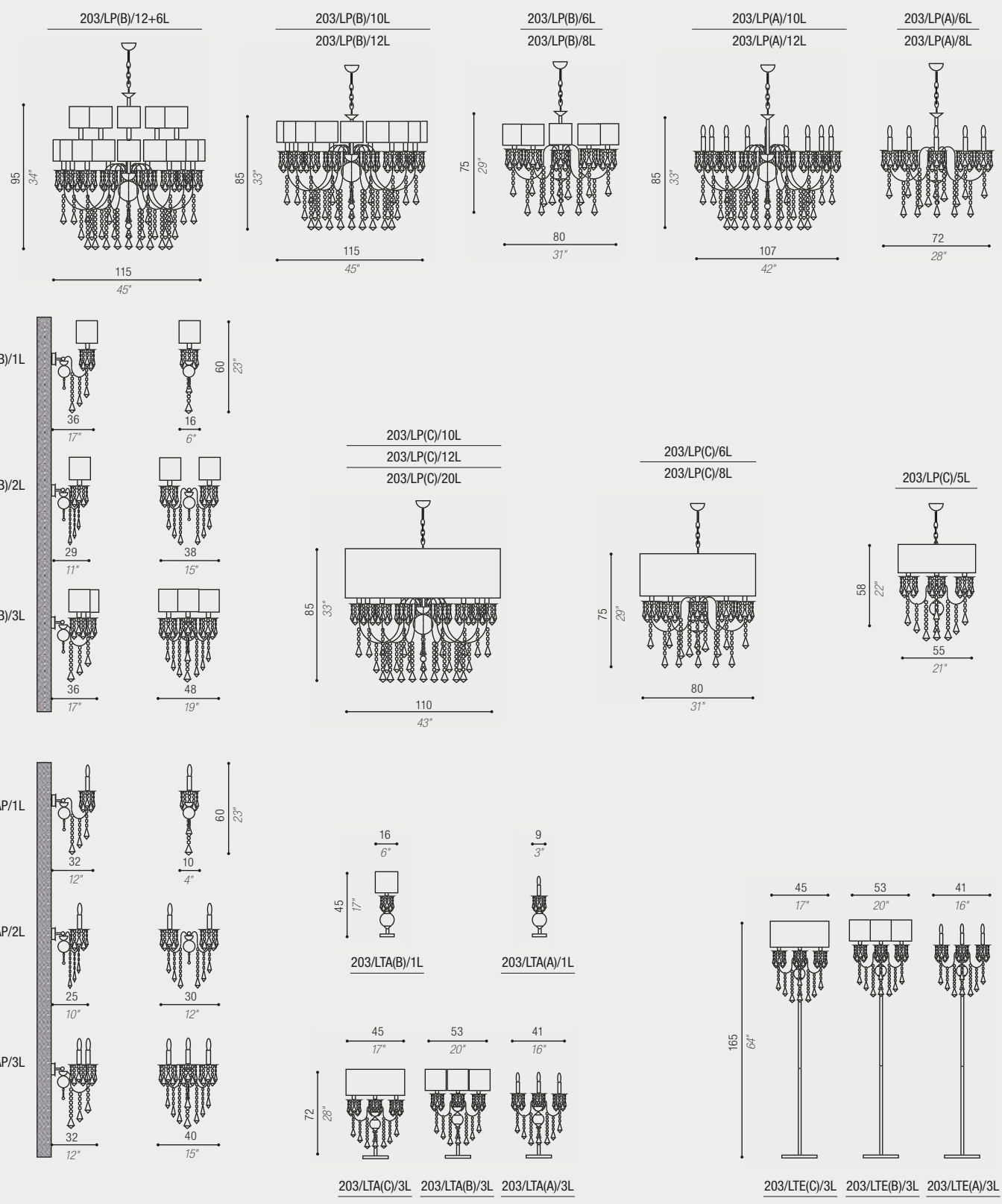

versioni disponibili



legenda a pag. 175

5 W  
E14 LED  
Europe

5 W  
E12 LED  
USA &  
Canada



**NOTE** Le lampadine non sono incluse. Si raccomanda l'uso di prodotti di alta qualità OSRAM o PHILIPS.  
Bulbs are not included. The use of high quality OSRAM or PHILIPS products is recommended.  
Лампочки не включены. Рекомендуется использовать высококачественные продукты OSRAM или PHILIPS.

333 series

# CAMILLA

senzazioni italiane  
*Italian feelings*  
Итальянские чувства

Struttura: ottone e parti in metallo  
Diffusori: paralumi cilindrici in tessuto  
Finiture: cromo lucido, oro lucido, oro satinato, nichel satinato, nichel nero, rame lucido, rame satinato, bronzo scuro, bianco  
Rosoni a soffitto: in metallo

*Structure: brass and metal parts*  
*Diffusers: cylindrical fabric lampshades*  
*Finishing: polished chrome, polished gold, satin gold, satin nickel, black nickel, polished copper, satin copper, dark bronze, white*

Структура: латунь и металлические элементы  
Рассеиватели: цилиндрические абажуры из ткани  
Отделки: полированный хром, полированное золото, золото сатин, никель сатин, никель черный, Полированная медь, Матовая медь, Темная бронза, Белый  
Потолочная роза: металл







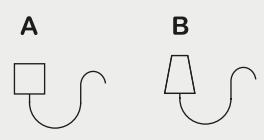
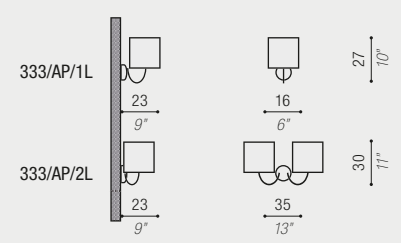
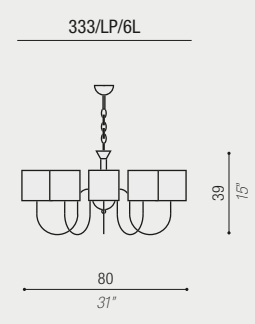
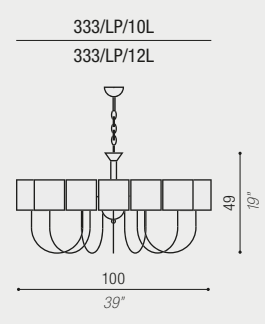
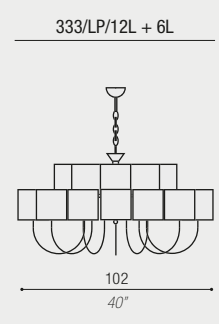

versioni disponibili



legenda a pag. 175

 5 W  
E14 LED Europe

5 W  
E12 LED USA & Canada



**NOTE** Le lampadine non sono incluse. Si raccomanda l'uso di prodotti di alta qualità OSRAM o PHILIPS.  
Bulbs are not included. The use of high quality OSRAM or PHILIPS products is recommended.  
Лампочки не включены. Рекомендуется использовать высококачественные продукты OSRAM или PHILIPS.

135 series

# ALICE

il silenzio della luce, pura seduzione!  
*the silent of light, pure seduction!*

**Спокойствие света, настоящий соблазн!**

Struttura: ottone e parti in metallo

Finitura: laccato bianco

Diffusori: paralumi cilindrici in tessuto rigido

Decorazioni pendenti: sfere di vetro con gocce di cristallo sfaccettate

Rosoni a soffitto: in metallo

*Structure: brass and metal parts*

*Finishing: lacquered white*

*Diffusers : conical lampshades in stiff fabric*

*Pendants decorations: glass beads, with crystal drops faceted*

*Finishing: polished chrome, polished gold, satin gold, satin nickel*

*Ceiling roses: Metal*

Структура: латунь и металлические элементы с применением белого лака

Рассеиватели: цилиндрические абажуры из плотной ткани

Подвески: стеклянные бусины и граненые кристаллы каплевидной формы

Отделки: полированный хром, полированное золото, золото сатин, никель сатин

Потолочная роза: металл















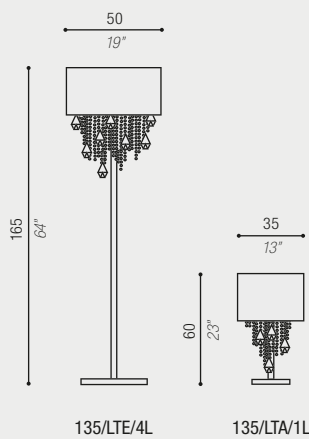
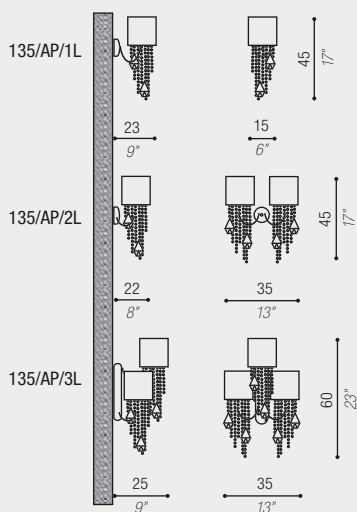
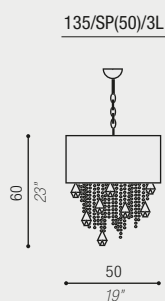
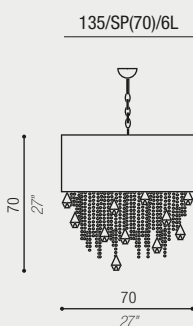
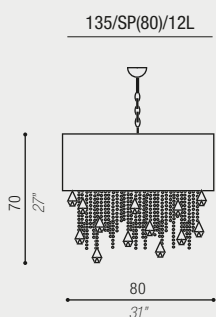
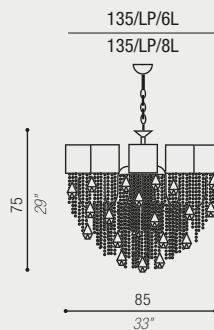
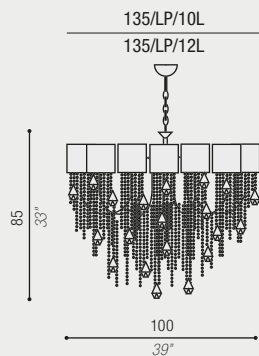

versioni disponibili



legenda a pag. 175

		Europe
15 W E27 LED	5 W E14 LED	
		USA & Canada
8 W E26 LED	5 W E12 LED	



**NOTE** Le lampadine non sono incluse. Si raccomanda l'uso di prodotti di alta qualità OSRAM o PHILIPS.

Bulbs are not included. The use of high quality OSRAM or PHILIPS products is recommended.

Лампочки не включены. Рекомендуется использовать высококачественные продукты OSRAM или PHILIPS.

100 series

# OTTAGONO

illuminazione versatile, unità modulari per speciali esigenze  
*versatile lighting, modular units for special needs*

универсальное освещение, возможность персонализации композиции  
благодаря модульной системе

Struttura: ottone e parti in metallo

Diffusori: paralumi troncoconici in tessuto rigido

Bobeches in vetro smerigliato: disponibili in trasparente

Decorazioni pendenti: gocce di cristallo sfaccettate

Finiture: cromo lucido, oro lucido, oro satinato, nichel satinato

*Structure: brass and metal parts*

*Diffusers: truncated conical fabric lampshades*

*Bobeches in ground glass: available either in transparent*

*Pendants decorations: faceted crystal drops*

*Finishing: polished chrome, polished gold, satin gold, satin nickel*

Структура: латунь и металлические элементы

Рассеиватели: абажуры в форме усеченного конуса из плотной ткани

Розетки: в матовом стекле, доступны и в прозрачном

Подвески: каплевидные граненые кристаллы

Отделки: полированный хром, полированное золото, золото сатин, никель сатин















100/SP/S.C./6L + 12L + 6L

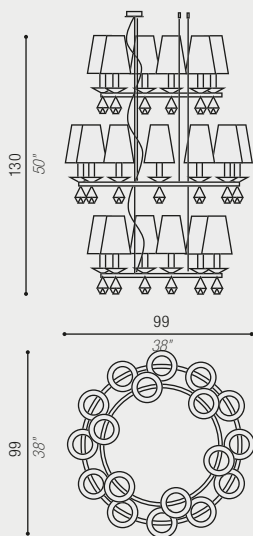

100/SP/S.C./10L + 5L  
100/SP/S.C./12L + 6L  
100/SP/S.C./14L + 7L

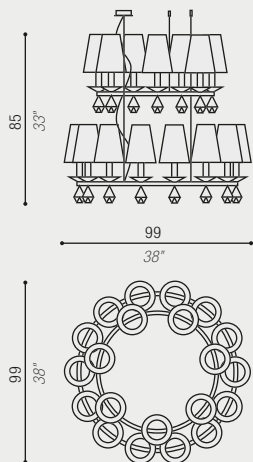

100/SP/S.C./10L  
100/SP/S.C./12L  
100/SP/S.C./14L

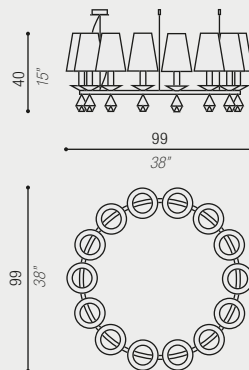

100/SP/S.C./6L  
100/SP/S.C./7L  
100/SP/S.C./8L

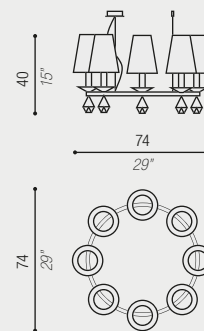

100/SP/S.R./14L

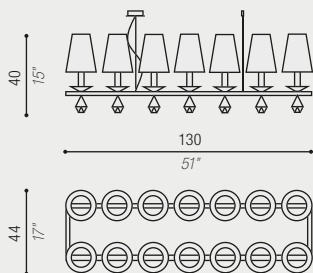

100/SP/S.R./10L  
100/SP/S.R./12L

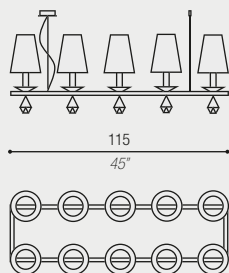

100/SP/S.R./8L

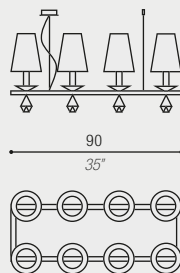

100/SP/S.R./6L

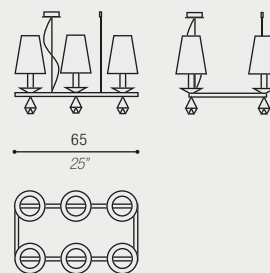

100/SPL/6L

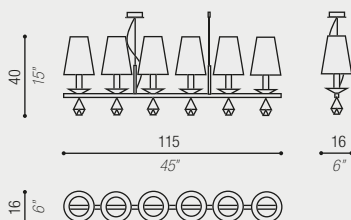

100/AP/1L  
100/AP/2L  
100/AP/3L

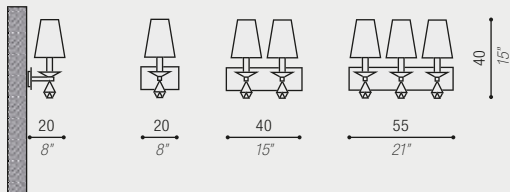

versioni disponibili



legenda a pag. 175



5 W  
E14 LED Europe

5 W  
E12 LED USA & Canada



**NOTE** Le lampadine non sono incluse. Si raccomanda l'uso di prodotti di alta qualità OSRAM o PHILIPS.

Bulbs are not included. The use of high quality OSRAM or PHILIPS products is recommended.

Лампочки не включены. Рекомендуется использовать высококачественные продукты OSRAM или PHILIPS.

328 series

# METROPOLITAN

geometrie di luci  
*geometries of lights*  
Геометрия света

Struttura: ottone e parti in metallo  
Finiture: cromo lucido, oro lucido, oro satinato, nichel satinato  
nichel nero, rame lucido, rame satinato, bronzo scuro, bianco  
Rosoni a soffitto: in metallo

*Structure: brass and metal parts*  
*Finishing: polished chrome, polished gold, satin gold, satin nickel,*  
*black nichel, polished copper, satin copper, dark bronze, white*  
*Ceiling roses: Metal*

Структура: латунь и металлические элементы  
Отделки: полированный хром, полированное золото, золото  
сатин, никель сатин никель черный, Полированная медь,  
Матовая медь, Темная бронза, Белый  
Потолочная роза: металл





















METROPOLITAN  
series | 328

175 ALARDINI

ALARDINI 176





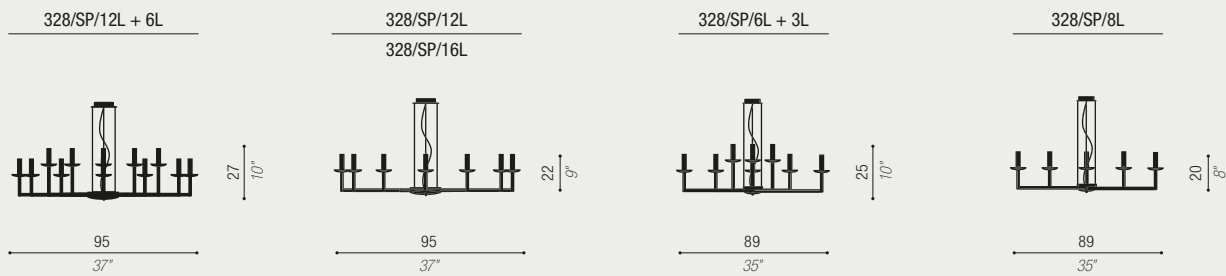

328/SP/3L

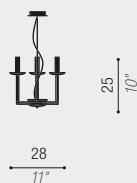

328/LTE/5L

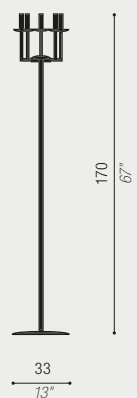

328/LTA/3L

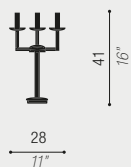

328/AP/1L



328/AP/3L

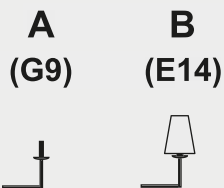

versioni disponibili



legenda a pag. 175

 bi-spina  
G9 LED

Europe

USA &  
Canada



**NOTE** Le lampadine non sono incluse. Si raccomanda l'uso di prodotti di alta qualità OSRAM o PHILIPS.

Bulbs are not included. The use of high quality OSRAM or PHILIPS products is recommended.

Лампочки не включены. Рекомендуется использовать высококачественные продукты OSRAM или PHILIPS.

126 series

# ELEGANCE

luci e ombre, sensazioni magiche!  
*lights and shadows, magic sensations!*  
игра света и тени дарит волшебные ощущения!

Struttura: ottone e parti in metallo  
Diffusori: paralumi troncoconici in tessuto rigido  
Decorazioni pendenti: perle sfaccettate in cristallo chiaro e gocce sfaccettate in cristallo ambra Swarovski  
Finiture: cromo lucido, oro lucido, oro satinato, nichel satinato

*Structure: brass and metal parts  
Diffusers: truncated conical fabric lampshades  
Pendants decorations: clear faceted crystal beads and amber crystal drops Swarovski  
Finishing: polished chrome, polished gold, satin gold, satin nickel*

Структура: металл и элементы из латуни  
Рассеиватели: абажуры в форме усеченного конуса из плотной ткани  
Подвески: прозрачные граненые бусины из хрусталя и янтарные каплевидные граненые кристаллы Сваровски  
Отделки: полированный хром, полированное золото, золото сатин, никель сатин  
Потолочная роза: металл























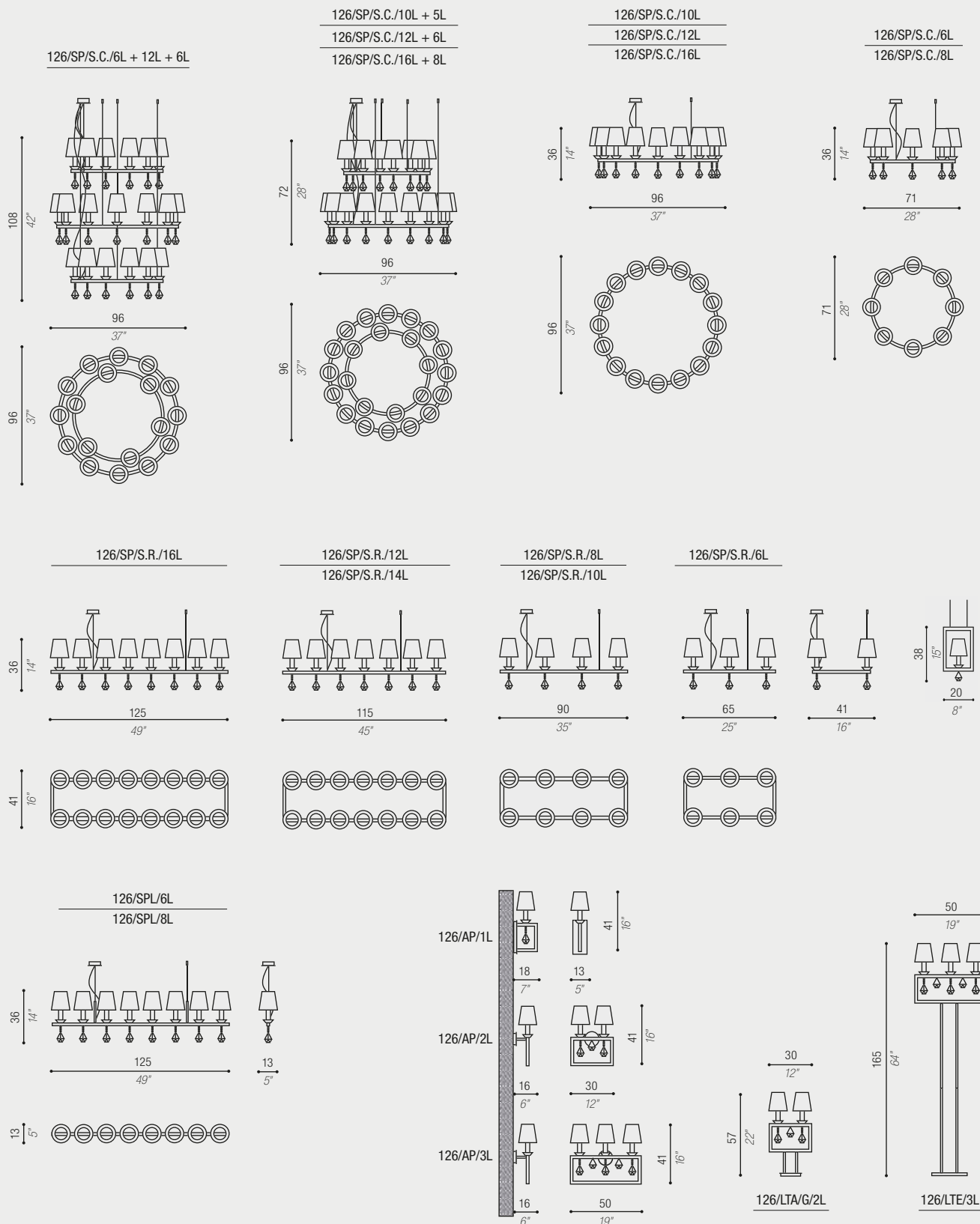

versioni disponibili



legenda a pag. 175

5 W  
E14 LED Europe

5 W  
E12 LED USA & Canada



**NOTE** Le lampadine non sono incluse. Si raccomanda l'uso di prodotti di alta qualità OSRAM o PHILIPS.

Bulbs are not included. The use of high quality OSRAM or PHILIPS products is recommended.

Лампочки не включены. Рекомендуется использовать высококачественные продукты OSRAM или PHILIPS.

204 series

# FLAVIA

l'incontro tra luce e design!  
*light and design meeting!*  
слияние дизайна и света!

Struttura: ottone e parti in metallo  
Diffusori: paralumi cilindrici in tessuto rigido  
Decorazioni pendenti: con catene e gocce in cristallo  
Finiture: cromo lucido, oro lucido, oro satinato, nichel satinato  
Rosoni a soffitto: in metallo

*Structure: brass and metal parts*  
*Diffusers: cylindrical fabric lampshades*  
*Pendants decorations: with chains and drops, crystal*  
*Ceiling roses: metal*

Структура: латунь и металлические элементы  
Рассеиватели: цилиндрические абажуры из плотной ткани  
Декор: подвески из кристаллов  
Отделки: полированный хром, полированное золото, золото сатин,  
никель сатин  
Потолочная роза: металл













ALARDINI 196



204/SP/12L + SP/1L

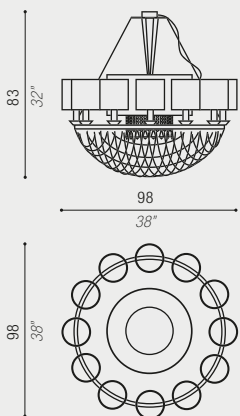

204/SP/10L + SP/1L

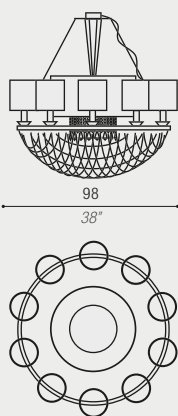

204/SP/8L + SP/1L

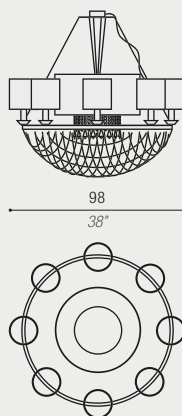

204/SP/6L

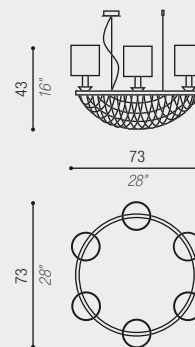

204/SP/12L

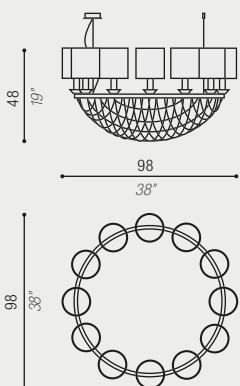

204/SP/10L

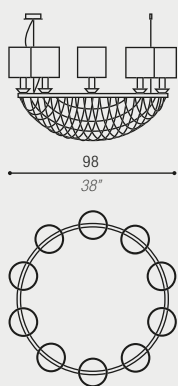

204/SP/8L

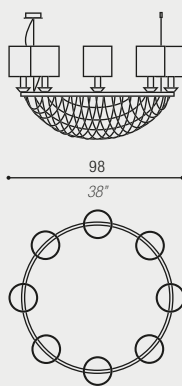

204/SP/1L

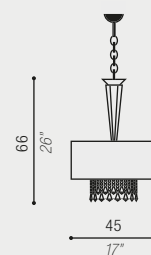

204/AP/1L

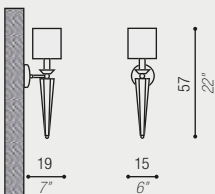

204/AP/2L

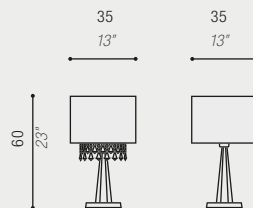
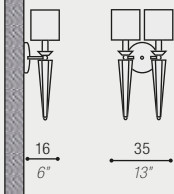

204(A)/LTA/1L 204(B)/LTA/1L

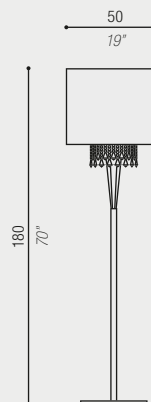

204/LTE/1L

versioni disponibili



legenda a pag. 175



**NOTE** Le lampadine non sono incluse. Si raccomanda l'uso di prodotti di alta qualità OSRAM o PHILIPS.

Bulbs are not included. The use of high quality OSRAM or PHILIPS products is recommended.

Лампочки не включены. Рекомендуется использовать высококачественные продукты OSRAM или PHILIPS.

120 series

# SINFONIA

antica arte del vetro soffiato, un segreto veneziano!  
*ancient art of blown glass, a Venetian secret!*  
**старые традиции венецианских стеклодувов!**

Struttura: ottone e parti in metallo  
Diffusori: paralumi troncoconici in tessuto rigido  
vetri soffiati veneziani in bianco lucido  
Decorazioni pendenti: gocce di vetro veneziano  
disponibili in bianco, nero oppure ambra  
Finiture : cromo lucido, oro lucido, oro satinato, nichel satinato

*Structure: brass and metal parts  
Speakers: conical lampshades in stiff fabric  
Venetian blown glass in gloss white  
Decorations pendants: drops of Venetian glass  
Available in white, black or amber  
Finishes: polished chrome, polished gold, satin gold, satin nickel*

Структура: латунь и металлические элементы  
Рассеиватели: абажуры в форме усеченного конуса из плотной ткани  
Декор: подвески из венецианского стекла, доступны в белом, черном и янтарном цветах  
Отделка: полированный хром, полированное золото, золото сатин, никель сатин













SINFONIA  
series | 120

203  
MARDINI



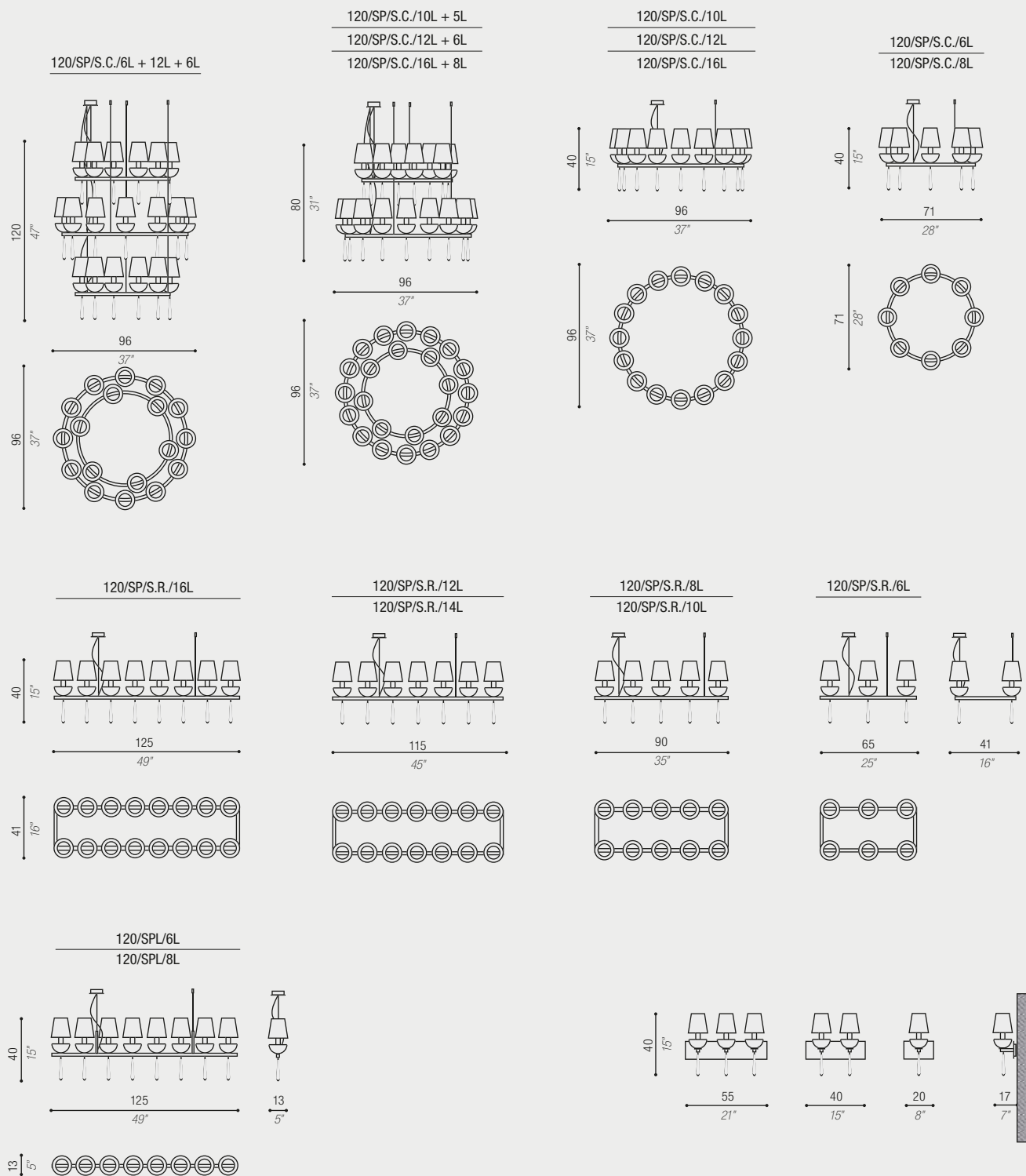

versioni disponibili



legenda a pag. 175



5 W  
E14 LED Europe  
5 W  
E12 LED USA & Canada



**NOTE** Le lampadine non sono incluse. Si raccomanda l'uso di prodotti di alta qualità OSRAM o PHILIPS.

Bulbs are not included. The use of high quality OSRAM or PHILIPS products is recommended.

Лампочки не включены. Рекомендуется использовать высококачественные продукты OSRAM или PHILIPS.



121 series

## CHANEL

Un concetto giovane, design raffinato ma essenziale!

*A young concept, refined but essential design!*

**Новая концепция, утонченный и выразительный дизайн!**

Struttura: ottone e parti in metallo

Diffusori: paralumi troncoconici in tessuto rigido bianco o nero

Decorazioni pendenti: gocce sfaccettate in cristallo Swarovski

*Structure: brass and metal parts*

*Diffusers: conical lampshades fabric stiff white or black*

*Hanging decorations: faceted Swarovski crystal drops*

Структура: латунь и металлические элементы

Рассеиватели: абажуры в форме усеченного конуса из плотной ткани в черной и белой версиях

Декор: граненые кристаллы Сваровски

Отделки: полированный хром, полированное золото, золото сатин, никель сатин







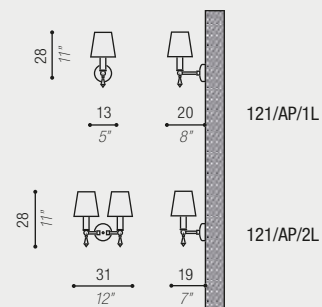
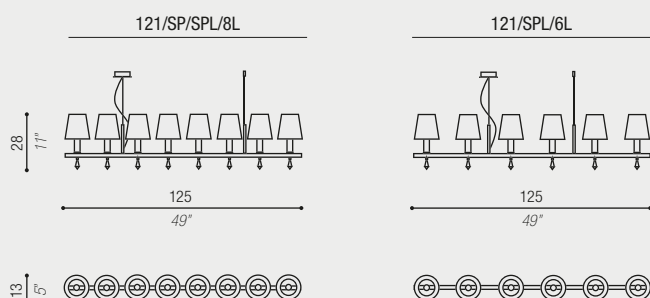
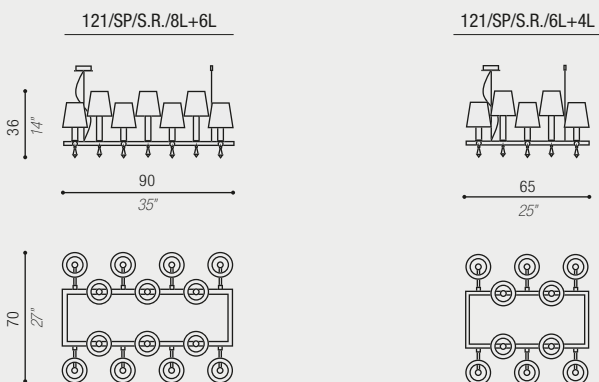
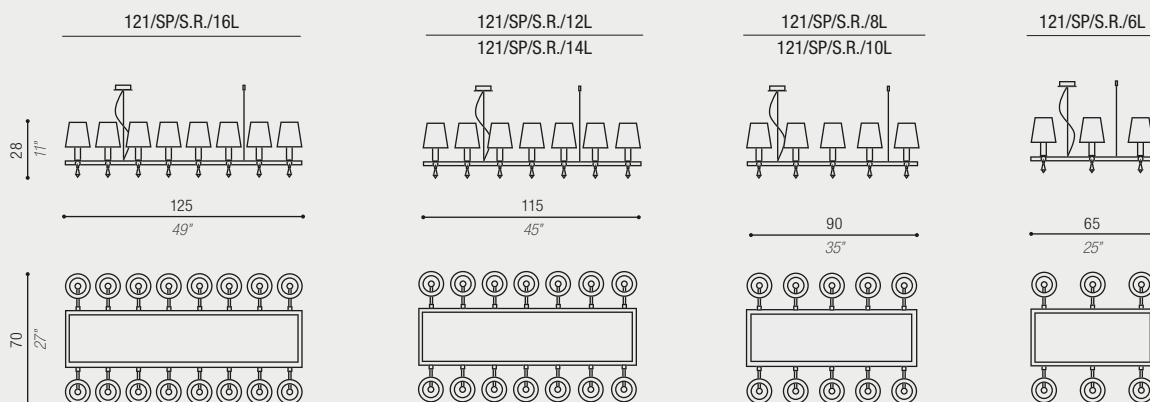

versioni disponibili



legenda a pag. 175



5 W  
E14 LED Europe  
5 W  
E12 LED USA & Canada



**NOTE** Le lampadine non sono incluse. Si raccomanda l'uso di prodotti di alta qualità OSRAM o PHILIPS.

Bulbs are not included. The use of high quality OSRAM or PHILIPS products is recommended.

Лампочки не включены. Рекомендуется использовать высококачественные продукты OSRAM или PHILIPS.

101 series

# GINEVRA

l'incontro tra luce e design!  
*light and design meeting!*  
слияние дизайна и света!

Struttura: ottone e parti in metallo  
Diffusori: paralumi cilindrici in tessuto  
Decorazioni pendenti: gocce di cristallo sfaccettate  
Finiture: cromo lucido, oro satinato, nichel satinato

*Structure: brass and metal parts  
Diffusers: cylindrical fabric lampshades  
Pendants decorations: faceted crystal drops  
Finishing: polished chrome, polished gold, satin gold, satin nickel*

Структура: латунь и металлические элементы  
Рассеиватели: цилиндрические абажуры из ткани  
Подвесы: каплевидные граненые кристаллы  
Отделки: полированный хром, полированное золото, золото сатин,  
никель сатин



















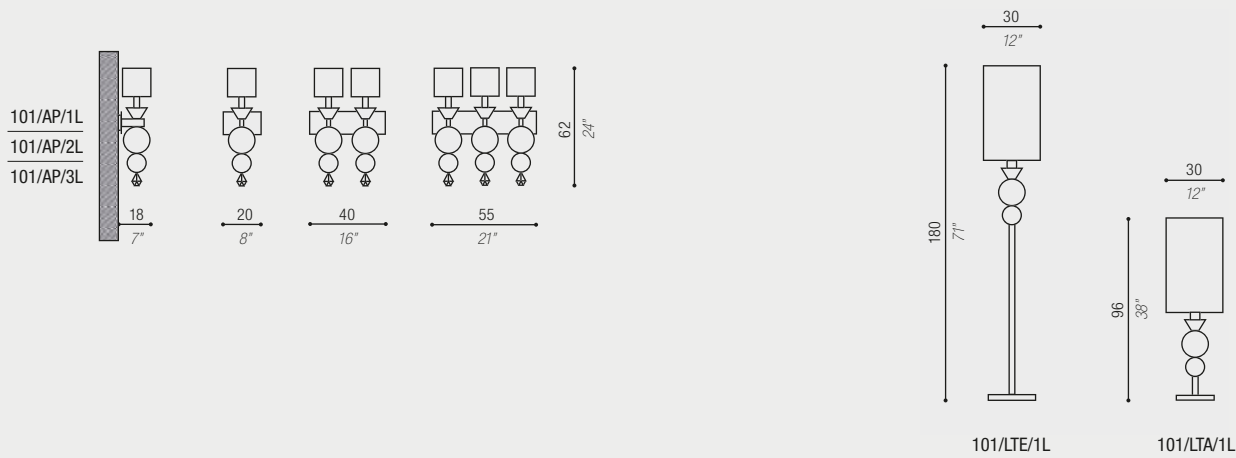
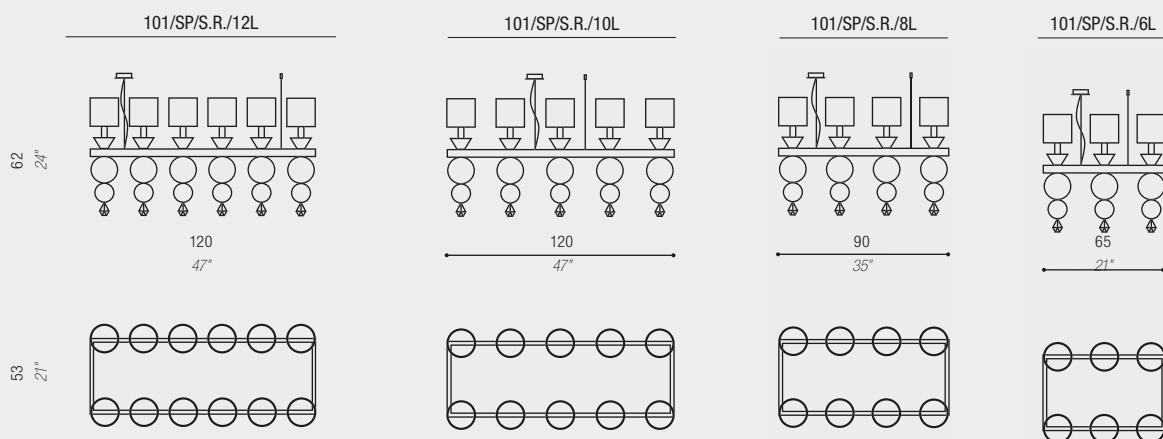
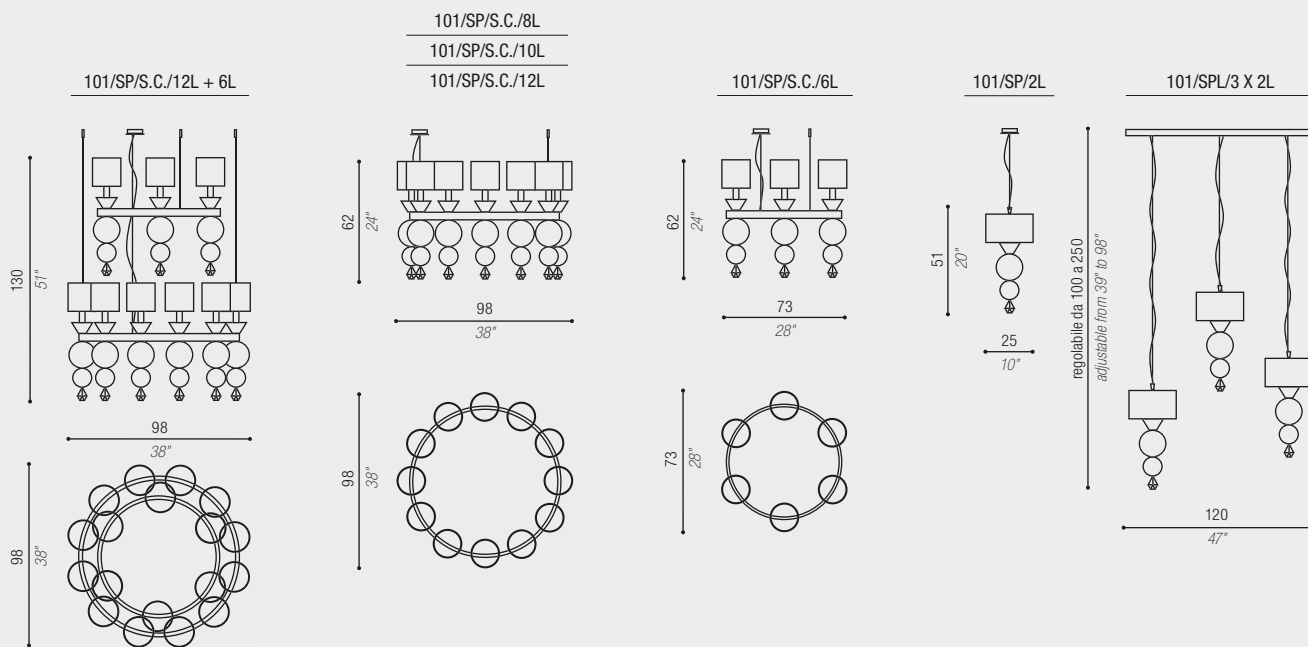

versioni disponibili



legenda a pag. 175

	15 W E27 LED	5 W E14 LED	Europe
	8 W E26 LED	5 W E12 LED	USA & Canada



**NOTE** Le lampadine non sono incluse. Si raccomanda l'uso di prodotti di alta qualità OSRAM o PHILIPS.

Bulbs are not included. The use of high quality OSRAM or PHILIPS products is recommended.

Лампочки не включены. Рекомендуется использовать высококачественные продукты OSRAM или PHILIPS.

321 series

# JOLIE

passioni di luce  
*passions of light*  
Страсть света

Struttura: ottone e parti in metallo

Finiture: cromo lucido, oro lucido, oro satinato, nichel satinato  
nichel nero, rame lucido, rame satinato, bronzo scuro, bianco

Rosoni a soffitto: in metallo

*Structure: brass and metal parts*

*Finishing: polished chrome, polished gold, satin gold, satin nickel,  
black nickel, polished copper, satin copper, dark bronze, white*

*Ceiling roses: Metal*

Структура: латунь и металлические элементы

Отделки: полированный хром, полированное золото, золото  
сатин, никель сатин никель черный, Полированная медь,  
Матовая медь, Темная бронза, Белый

Потолочная роза: металл















ALARDINI 226



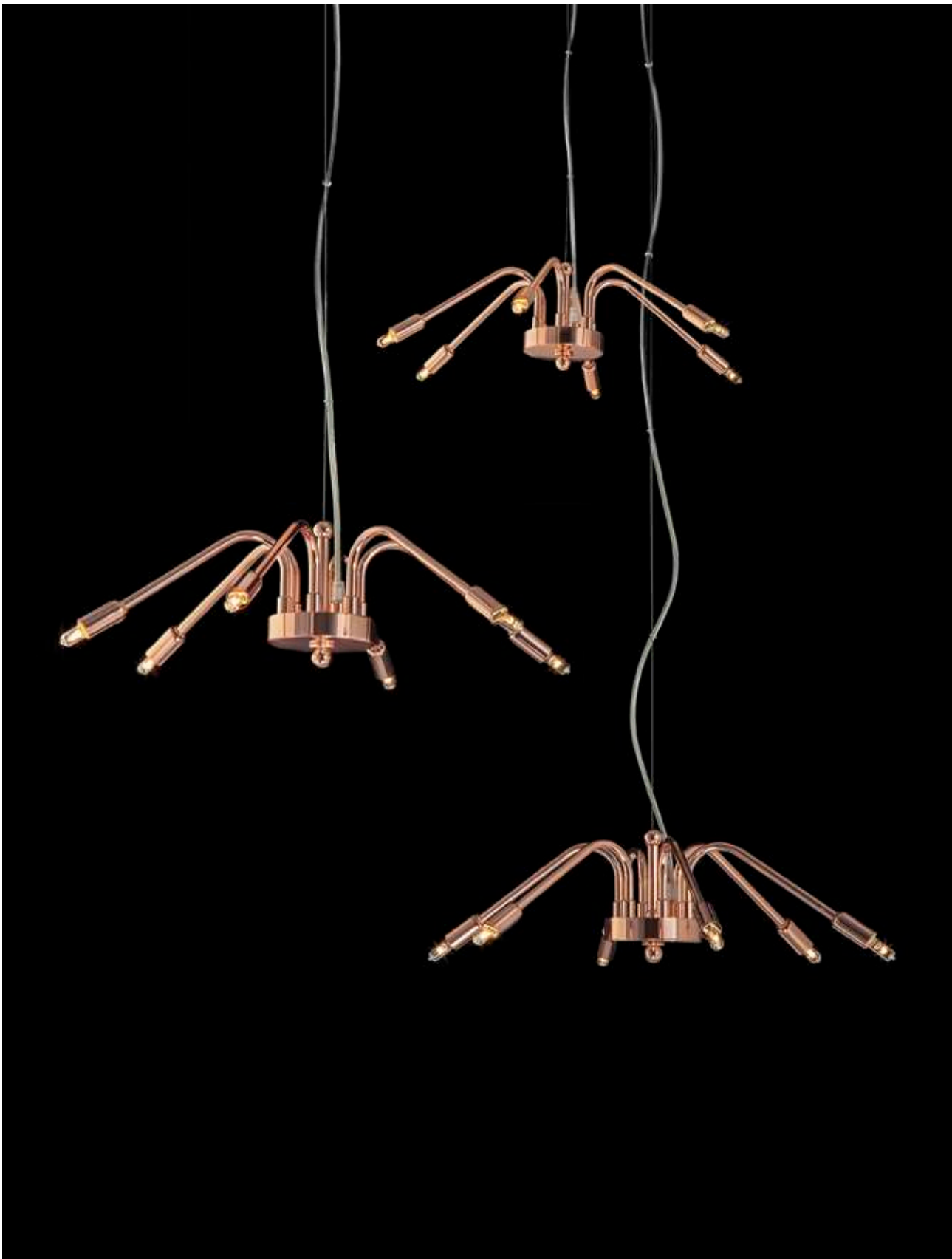

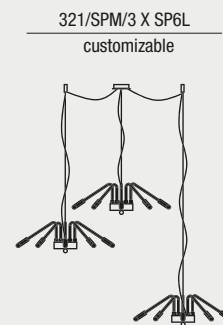
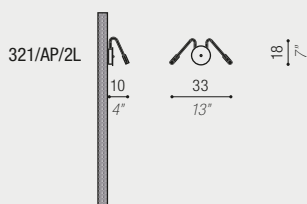
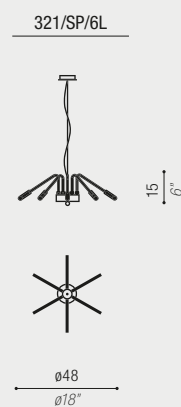
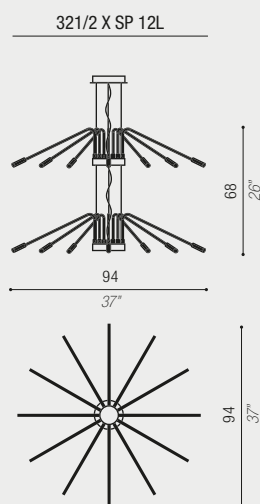
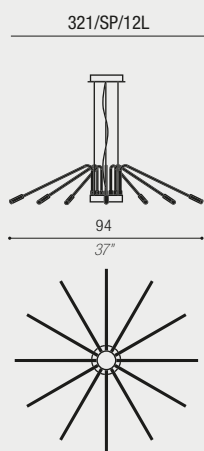
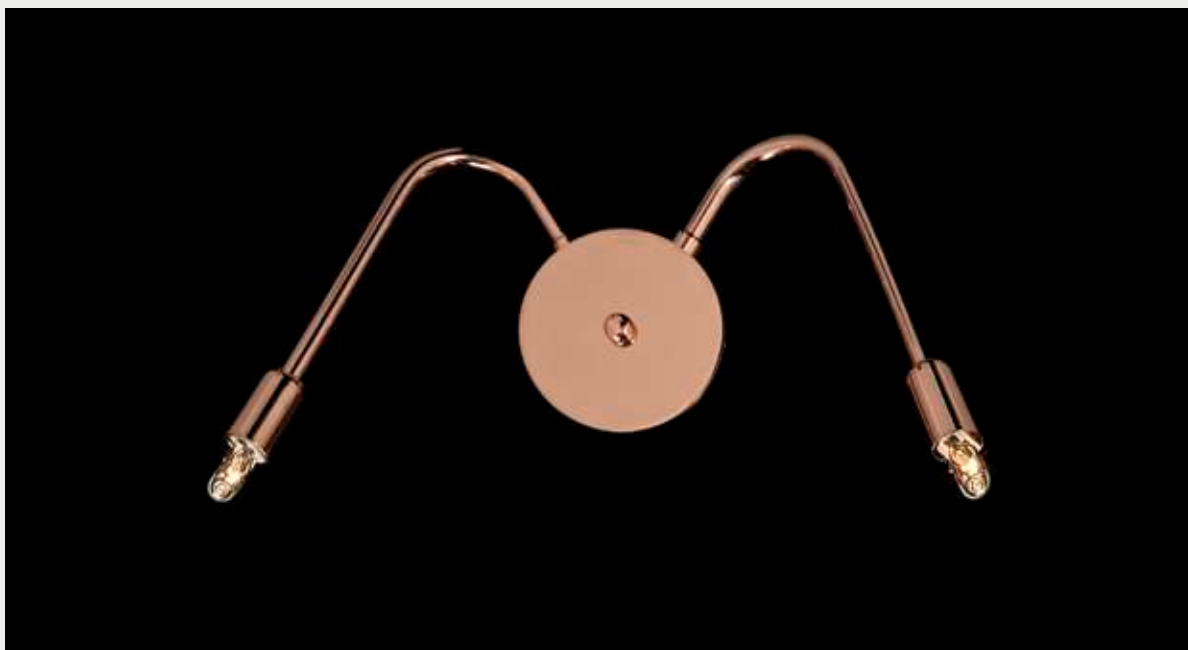

versioni disponibili



legenda a pag. 175



**NOTE** Le lampadine non sono incluse. Si raccomanda l'uso di prodotti di alta qualità OSRAM o PHILIPS.

Bulbs are not included. The use of high quality OSRAM or PHILIPS products is recommended.

Лампочки не включены. Рекомендуется использовать высококачественные продукты OSRAM или PHILIPS.

331 series

# LOLITA

concetti minimali  
*minimal concepts*  
Минимальные понятия

Struttura: ottone e parti in metallo  
Finiture: cromo lucido, oro lucido, oro satinato, nichel satinato  
nichel nero, rame lucido, rame satinato, bronzo scuro, bianco  
Rosoni a soffitto: in metallo

*Structure: brass and metal parts*  
*Finishing: polished chrome, polished gold, satin gold, satin nickel,*  
*black nichel, polished copper, satin copper, dark bronze, white*  
*Ceiling roses: Metal*

Структура: латунь и металлические элементы  
Отделки: полированный хром, полированное золото, золото  
сатин, никель сатин никель черный, Полированная медь,  
Матовая медь, Темная бронза, Белый  
Потолочная роза: металл













AARDINI 236



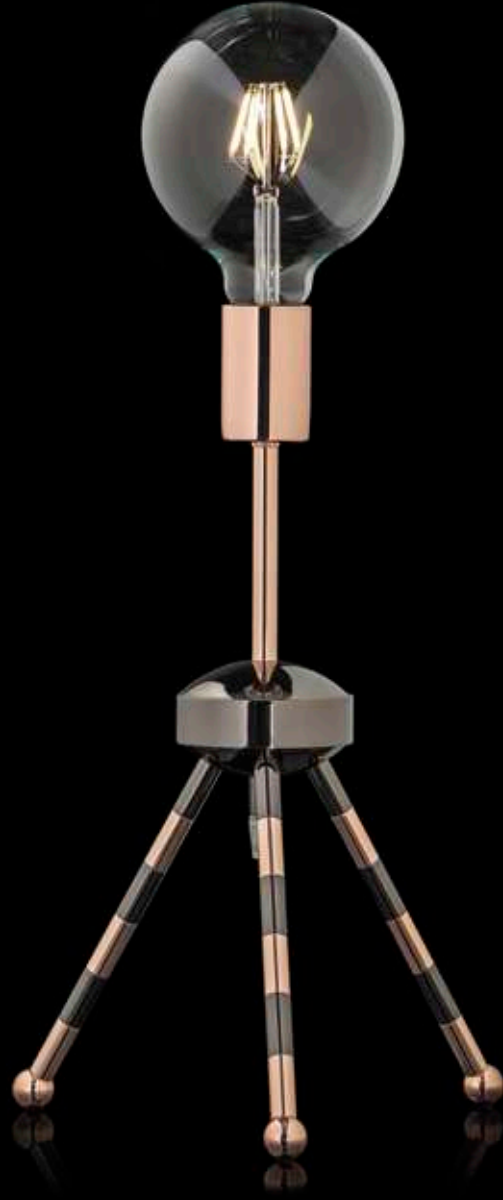



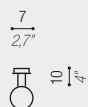
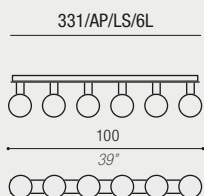

**LS**  
Lampada a soffitto  
Ceiling lamp  
Потолочный светильник

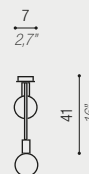
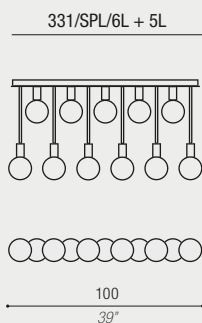
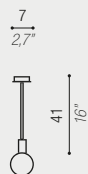
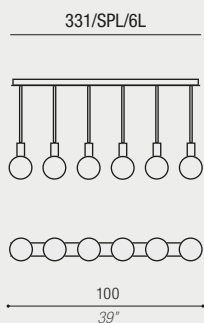

331/AP/LS/3L

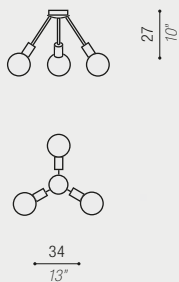

331/LS + Flex/1L

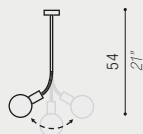

331/D Flex/AP/LS/1L



331(A)/AP/LS/1L

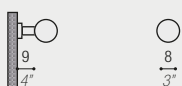

331(B)/AP/1L

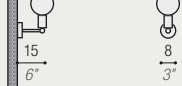

331(C)/AP/1L

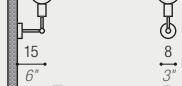

331(D Flex)/AP/LS/1L

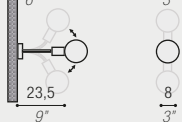

331/LTA/1L

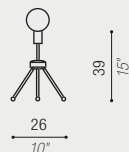

versioni disponibili



legenda a pag. 175



15 W  
E27 LED

Europe

8 W  
E26 LED

USA &  
Canada



**NOTE** Le lampadine non sono incluse. Si raccomanda l'uso di prodotti di alta qualità OSRAM o PHILIPS.  
Possibilità di acquisto in versione monocolori o bicolore.

Bulbs are not included. The use of high quality OSRAM or PHILIPS products is recommended.  
Possibility to purchase in a single-color or two-color version.

Лампочки не включены. Рекомендуется использовать высококачественные продукты OSRAM или PHILIPS.  
Возможность покупки в одноцветной или двухцветной версии.



323 series

# DOMENIQUE

momenti di luce  
*moments of light*  
Моменты света

Struttura: ottone e parti in metallo

Diffusori: paralumi troncoconici in tessuto rigido, schermo in plex

Finiture: cromo lucido, oro lucido, oro satinato, nichel satinato, nichel nero, rame lucido, rame satinato, bronzo scuro, bianco

Rosoni a soffitto: in metallo

*Structure: brass and metal parts*

*Diffusers: truncatedcone fabric lampshades plex screen*

*Finishing: polished chrome, polished gold, satin gold, satin nickel, black nickel, polished copper, satin copper, dark bronze, white*

*Ceiling roses: Metal*

Структура: латунь и металлические элементы

Рассеиватели: оттенки усеченного конуса из плотной ткани, плексный экран

Отделки: полированный хром, полированное золото, золото сатин, никель сатин никель черный, Полированная медь, Матовая медь, Темная бронза, Белый

Потолочная роза: металл





323/SP/4L/D.55

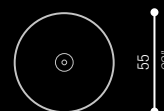
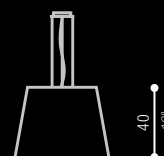

versioni disponibili



15 W  
E27 LED

Europe

8 W  
E26 LED

USA &  
Canada

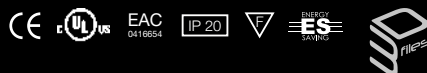

**NOTE** Le lampadine non sono incluse. Si raccomanda l'uso di prodotti di alta qualità OSRAM o PHILIPS.

*Bulbs are not included. The use of high quality OSRAM or PHILIPS products is recommended.*

Лампочки не включены. Рекомендуется использовать высококачественные продукты OSRAM или PHILIPS.

legenda a pag. 175

327 series

## JAZZ

la cultura della luce  
*the culture of light*  
Культура света

Struttura: ottone e parti in metallo  
Diffusori: vetro soffiato fumè trasparente, lavorato a mano a Venezia  
Finiture: cromo lucido, oro lucido, oro satinato, nichel satinato, nichel nero, rame lucido, rame satinato, bronzo scuro, bianco  
Rosoni a soffitto: in metallo

*Structure: brass and metal parts  
Diffuser: transparent smoke glass hand made in Venice  
Finishing: polished chrome, polished gold, satin gold, satin nickel, black nickel, polished copper, satin copper, dark bronze, white  
Ceiling roses: Metal*

Структура: латунь и металлические элементы  
Рассеиватель: прозрачное дымовое стекло ручной работы в Венеции  
Отделки: полированный хром, полированное золото, золото сатин, никель сатин никель черный, Полированная медь, Матовая медь, Темная бронза, Белый  
Потолочная роза: металл





243 ALARDINI

327/SP/1L

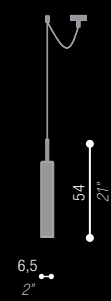

327/SPM/10L  
customizable

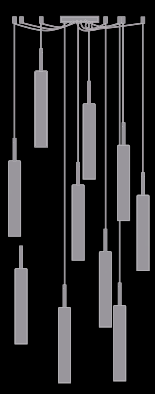

versioni disponibili



legenda a pag. 175

5 W  
E14 LED Europe

5 W  
E12 LED USA & Canada



**NOTE** Le lampadine non sono incluse. Si raccomanda l'uso di prodotti di alta qualità OSRAM o PHILIPS.  
*Bulbs are not included. The use of high quality OSRAM or PHILIPS products is recommended.*  
 Лампочки не включены. Рекомендуется использовать высококачественные продукты OSRAM или PHILIPS.



332 series

# TOGO

bagliori di luce  
*gleams of light*  
Отблески света

Struttura: ottone e parti in metallo

Finiture: cromo lucido, oro lucido, oro satinato, nichel satinato  
nichel nero, rame lucido, rame satinato, bronzo scuro, bianco

Rosoni a soffitto: in metallo

*Structure: brass and metal parts*

*Finishing: polished chrome, polished gold, satin gold, satin nickel,  
black nichel, polished copper, satin copper, dark bronze, white*

*Ceiling roses: Metal*

Структура: латунь и металлические элементы

Отделки: полированный хром, полированное золото, золото  
сатин, никель сатин никель черный, Полированная медь,  
Матовая медь, Темная бронза, Белый

Потолочная роза: металл



245 ALARDINI

332/SP/6L + 6L

332/SP/12L + 12L

332/SP/(12L+12L) + (6L+6L)

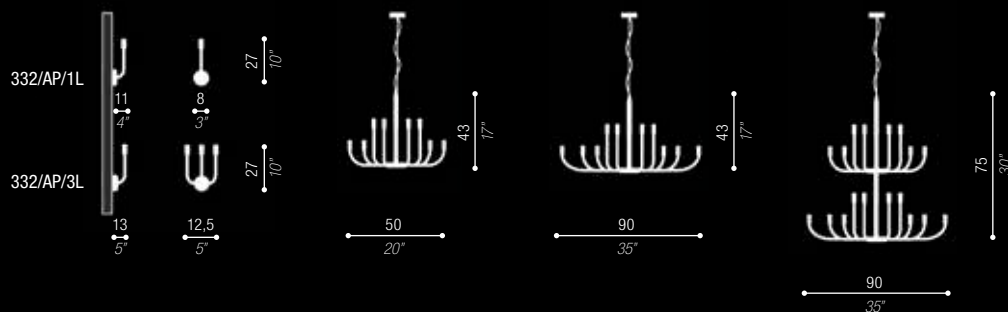

versioni disponibili



legenda a pag. 175

  
bi-spina  
G9 LED  
Europe  
USA &  
Canada



**NOTE** Le lampadine non sono incluse. Si raccomanda l'uso di prodotti di alta qualità OSRAM o PHILIPS.

*Bulbs are not included. The use of high quality OSRAM or PHILIPS products is recommended.*

Лампочки не включены. Рекомендуется использовать высококачественные продукты OSRAM или PHILIPS.



133 series

## MELODY

luci preziose nel vento!  
*precious lights in the wind!*  
блеск огней на ветру!

Struttura: ottone e parti in metallo  
Decorazioni pendenti: catene di cristallo Swarovski  
Finiture: cromo lucido, oro lucido, oro satinato, nichel satinato

*Structure: brass and metal parts  
Decorations hanging chains Swarovski Crystal  
Finishes: polished chrome, polished gold, satin gold, satin nickel*

Структура: латунь и металлические элементы  
Декор: цепочки кристаллов Сваровски  
Отделки: полированный хром, полированной золото, золото сатин, никель сатин



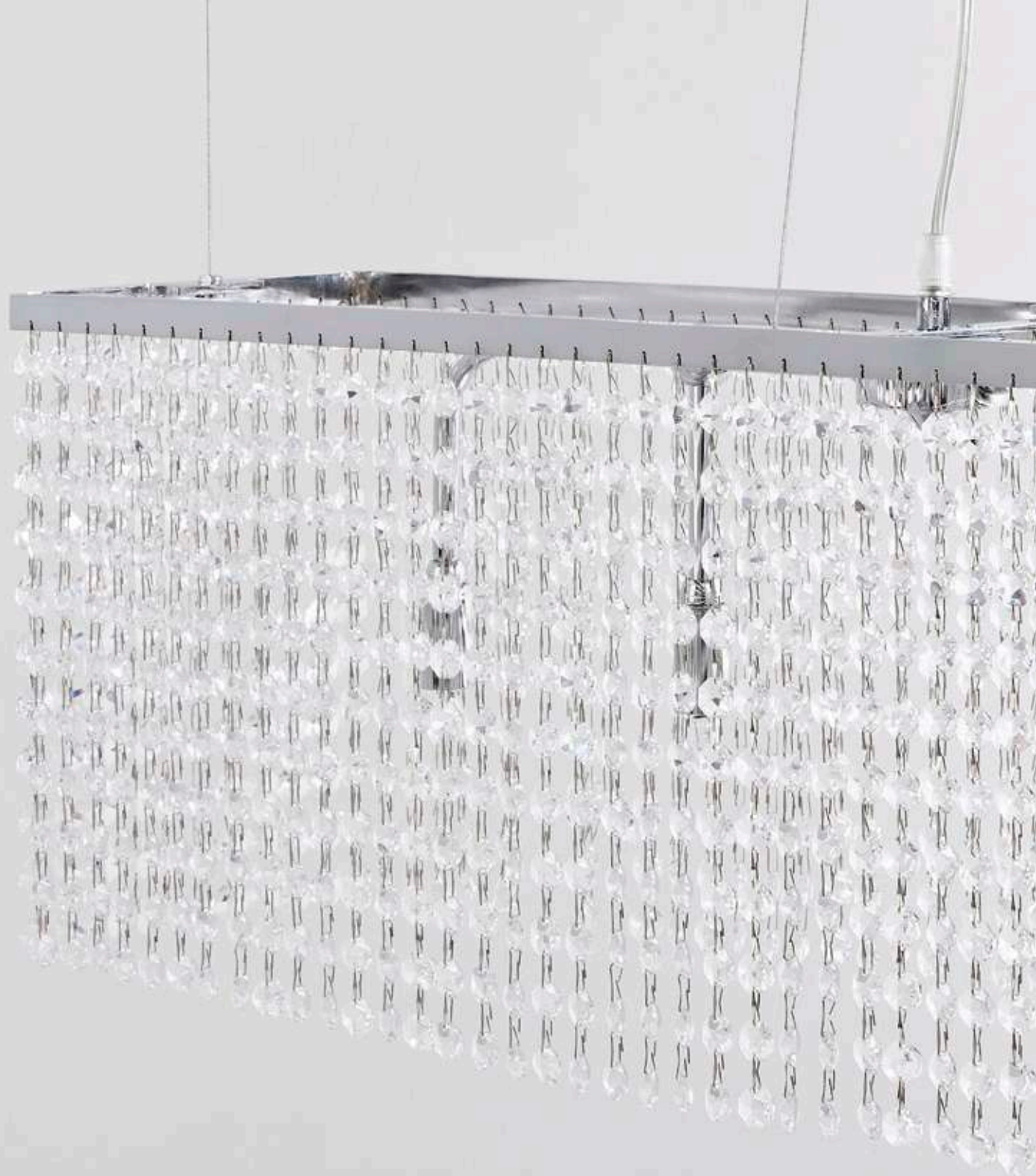



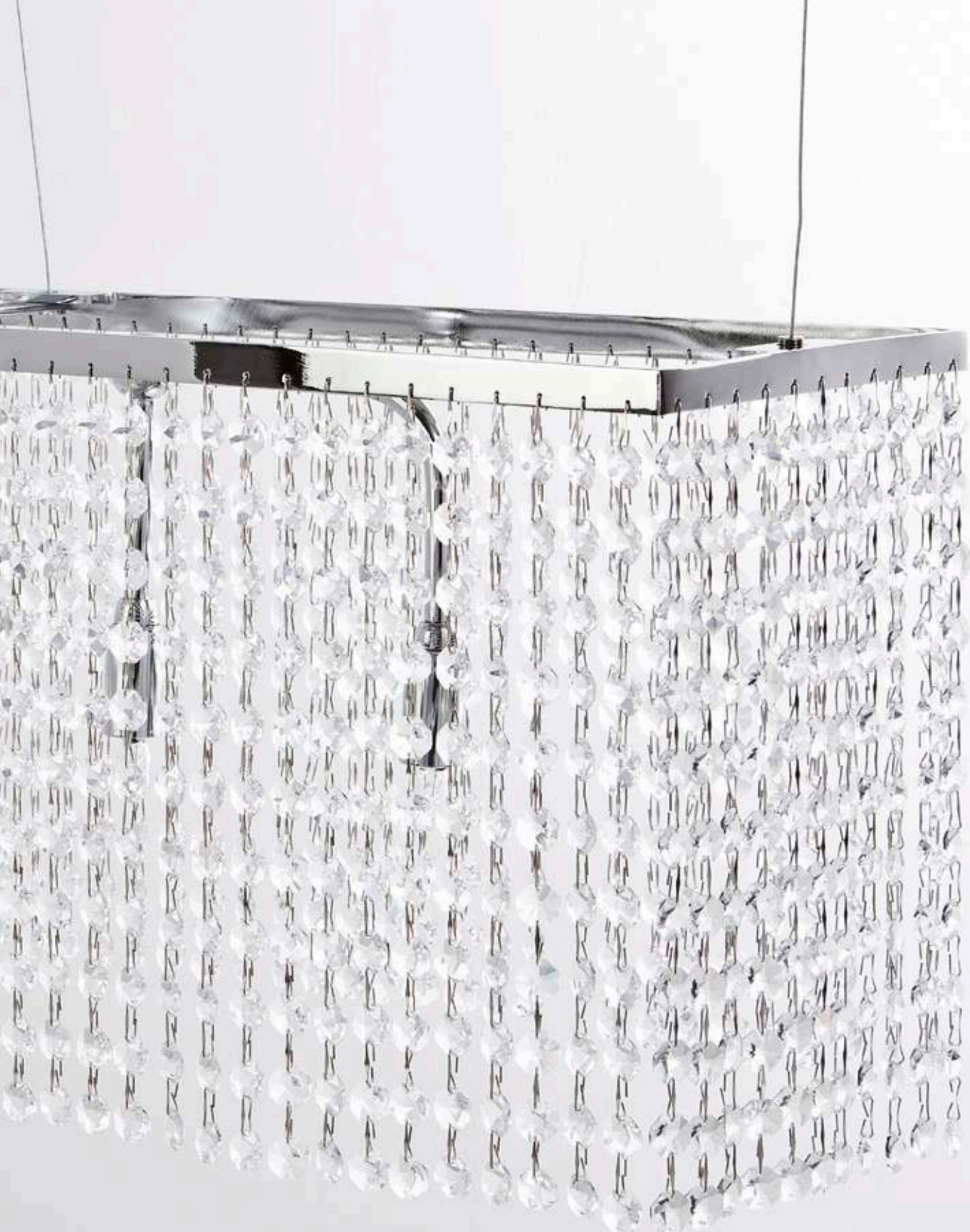



AARDINI 250

133/SP/120X40(H70)/24L

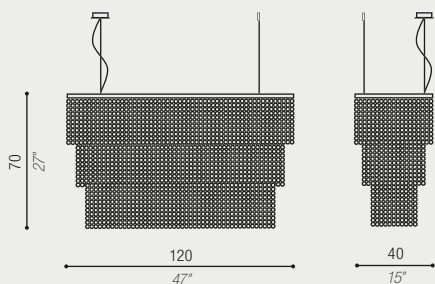

133/SP/40X40(H70)/10L

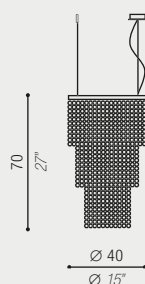

133/SP/120X30(H25)/10L

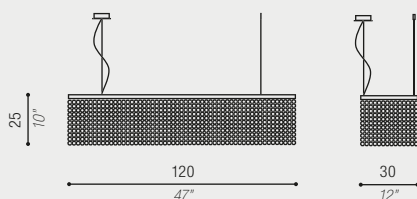

133/SP/100X30(H25)/8L

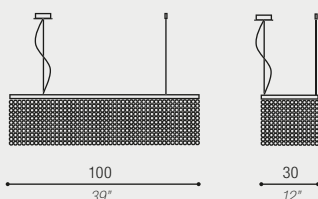

133/SP/80X30(H25)/6L

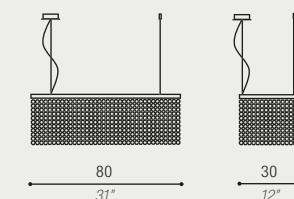

133/SP/15X15(H45)/1L

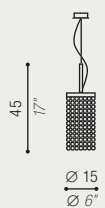

133/SP/25X25(H60)/3L

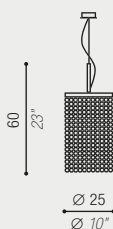

133/AP/1L  
133/AP/2L  
133/AP/3L

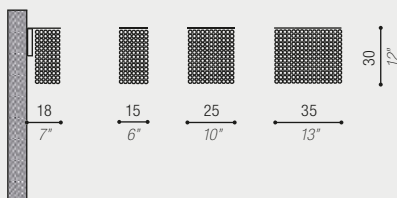

133/LTE/25X25(H160)/2L

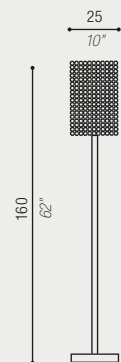

133/LTA/15X15(H35)/1L

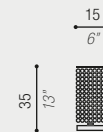

CRYSTALS/CRISTALLI

SHAPE AVAILABLE/ FORMA DISPONIBILE

OCTAGONAL	14 mm.	SQUARE	22 mm.
OTTAGONALE	14 mm.	QUADRATO	22 mm.

**A**



**B**



versioni disponibili



legenda a pag. 175

	5 W E14 LED	Europe
	5 W E12 LED	USA & Canada



**NOTE** Le lampadine non sono incluse. Si raccomanda l'uso di prodotti di alta qualità OSRAM o PHILIPS.

Bulbs are not included. The use of high quality OSRAM or PHILIPS products is recommended.

Лампочки не включены. Рекомендуется использовать высококачественные продукты OSRAM или PHILIPS.

Tipologie di paralumi  
Types of lampshades  
Типы абажуров

---



1



2



3



4



5



6



7



8



9



10



11



12



13

## Colori rivestimenti paralumi in creponne

Lamp shades colours in creponne

Цвета абажуров в крепоне



bianco  
white  
Белый

239

4003

4004

4506

4011

4005

nero

## Materiale paralumi disponibile

Lamp shades materials available

Материалы абажуров

cotone/cotton/хлопок

organza/organza/органза

cinette

creponne/creponne/крепон

Metalli disponibili  
Metals finishes  
Отделки металла

cromo lucido  
polished chrome  
полированный хром

nichel lucido  
polished nickel  
полированный никель

rame lucido  
polished copper  
блестящая медь

oro lucido  
polished gold  
блестящее золото

nichel nero lucido  
polished dark nickel  
блестящий черный  
никель

nichel satinato  
satin nickel  
атлас никель

nichel nero satinato  
satin dark nickel  
сатин черный никель

oro satinato  
satin gold  
атласное золото

rame satinato  
satin copper  
атласное медь

bronzo scuro  
dark bronze  
темная бронза

bronzo spazzolato  
dark bronze  
матовая бронза

rame spazzolato  
dark bronze  
матовая медь

bianco  
white  
белый

personalizzazioni e accessori

253  
MARDINI

Ci riserviamo che i colori indicati possono avere delle variazioni

We reserve the right for the slight variation of colours

Оттенки цветов могут несколько отличаться от образца

Colori rivestimenti paralumi in pongé

Lamp shades colours in pongé

Цвета абажуров в ткани понже

I tessuti sotto riportati sono per i paralumi in plissé

The above given materials are intended for plissé lamp shades

Вышеприведенные цвета ткани используются для абажуров в плиссе



Bordò  
*Bordeaux*  
Бордо

Rosa Antico  
*Ancient rose*  
Пепельная  
роза

Senape  
*Mustard*  
Горчиный

Giallo oro  
*Golden yellow*  
Золотистый  
желтый

04

03

Bianco  
*White*  
Белый



Nero  
*Black*  
Черный

Grigio scuro  
*Dark grey*  
Темно-серый

Marrone Bosco  
*Dark brown*  
Темно-  
коричневый

Nocciola Bosco  
*Light brown*  
Светло-  
Коричневый

Tortora  
*Tortora*  
Тортора



Bluette  
*Bluette*  
Синий

Celeste  
*Sky blue*  
Голубой

Lilla  
*Lila*  
Фиолетовый



file 3D disponibili  
available 3D files  
доступны 3D-файлы



**SPM**  
Lampada a sospensione multipla  
Multiple hanging lamp  
Несколько подвесной светильник



**LS**  
Lampada a soffitto  
Ceiling lamp  
Потолочный светильник



**LP**  
Lampadario  
Chandelier  
Люстра



**SP**  
Lampada a sospensione  
Hanging lamp  
Подвесной светильник



**SPL**  
Sospensione lineare  
Linear hanging lamps  
Линейные подвесные лампы



**LTE**  
Lampada da terra  
Floor lamp  
торшер



**AP**  
Lampada a muro  
Wall lamp  
Настенный светильник



**LTA**  
Lampada da tavolo  
Table lamp  
Настольная лампа



**sL**  
Struttura lineare  
Linear structure  
Линейная структура



**sC**  
Struttura circolare  
Circular structure  
Кольцевая структура



**sR**  
Struttura rettangolare  
Rectangular structure  
Прямоугольная структура



**MA**  
I moduli di questa lampada possono essere assemblati anche su diversi livelli  
The individual modules of this lamp can be assembled on multiple levels  
Модули этой лампы могут быть собраны и на разных уровнях



**H.r.**  
Altezza regolabile  
Adjustable height  
регулируемая по высоте



globo E27 LED  
globe E27 LED  
земной шар E27 LED



sfera smerigliata E27 LED  
frosted sphere E27 LED  
матовая лампочка E27 LED



sfera smerigliata E14 LED  
frosted sphere E14 LED  
матовая лампочка E14 LED



bi-spina G9 LED  
bi pin G9 LED  
Bi-Pin G9 LED

**VTRF**

vetro trasparente fumè  
transparent smoke glass  
прозрачное дымовое стекло

**VTR**

vetro trasparente  
transparent glass  
прозрачное стекло

**VBL**

vetro bianco latte  
white milk glass  
белый молочный стакан



L'apposizione del marchio CE attesta che la lampada ha tutte le caratteristiche richieste dalla normativa europea EN 60598-1, che corrispondono alla normativa italiana CEI 34-21  
The CE applied mark certifies that lighting fixture is in compliance with the standards required from the EN 60598-1 European regulations corresponding to CEI 34-21 Italian ones  
Маркировка CE удостоверяет, что лампа соответствует всем предъявляемым требованиям по Европейскому стандарту EN 60598-1, которые соответствуют действующим итальянским CEI 34-21



L'apposizione del marchio EAC attesta che il prodotto risulta conforme ai requisiti degli standard russi  
EAC - This certifies that the product is in conformity with the requirements laid down by the russian standards  
Нанесение EAC удостоверяет, что изделие соответствует требованиям российских стандартов



Indice di protezione dalla penetrazione nell'apparecchio di corpi solidi o liquidi  
Protection index against solids or liquids entrance  
Индекс защиты от проникновения в твердых или жидких веществ



L'apparecchio può essere installato su superfici normalmente infiammabili  
The lighting fixtures can be installed on normal flammable surfaces  
Устройство может быть установлено на легковоспламеняющихся поверхностях



In questo apparecchio possono essere installate lampadine fluorescenti a basso consumo energetico  
In this lighting fixture can be installed energy-saving fluorescent lamps  
Это устройство совместимо с люминесцентными лампами с низким потреблением энергии



Questo apparecchio è dotato di lampadine alogene auto-protette (a bassa pressione)  
This lighting fixture is equipped with self-shielded halogen lamps (low pressure)  
Этот светильник оснащен галогенными лампами с системой самозащиты (низкого давления)



Marchio di conformità del prodotto ai requisiti di sicurezza canadesi e statunitensi  
This listing Mark shows that the product is compliance with both Canadian and Us safety standards  
Отметка показывает, что продукт отвечает канадским и американским стандартам безопасности

special thanks to:  
Ciro Aiardo  
Maria Riccio  
Mariasaria Aiardo  
Olga Smirnova Design  
JP Interjero Studija  
Burj Al Arab  
W Barcelona Hotel  
Royal Continetal  
Prezioso  
Zonta

art direction  
**Luigi Aiardo**  
**Vincenzo Aiardo**

graphic design  
**OHOHdesign.it**

photographer  
**Giuseppe Matarazzo**

**AIARDINI**<sup>®</sup>  
MILANO

---



AIARDINI si riserva il diritto di modificare in qualsiasi momento e senza preavviso, caratteristiche tecniche ed estetiche degli oggetti presentati in questo catalogo l'unico miglioramento obiettivo.

*AIARDINI reserves the right to change, at any time and without notice, the technical and aesthetic features of the items illustrated in this catalogue with the sole aim improvement.*

AIARDINI оставляет за собой право изменять в любое время и без предварительного уведомления, технические и эстетические особенности артикулов, представленных в этом каталоге с единственной целью их улучшения.

**AIARDINI Illuminazione s.r.l.**  
www.aiardini.it · info@aiardini.it  
ph. > +39 081 81 89 125

**REGISTERED OFFICE AND ADMINISTRATION**  
via Giacomo Zanella 48/7 · 20133 Milan · Italy

**FACTORY AND SHOWROOM**  
Corso Europa, 27 · 80010 Villaricca · Italy