

CD
DAYTONA
MADE IN ITALY

LUXURY BRAND BY SIGNORINI&COCO

Kruger

Consolle - Console









Eros

Specchio - Mirror



Roger

Divano - Sofa







Russell

Pouff - Pouffe



Kruger

Tavolino - Side Table



Kruger

Console - Console





Report Bergere

Poltrona girevole - Swivel armchair





Report Bergere

Poltrona - Armchair





Report

Poltrona - Armchair







Report

Pouff - Pouffe



Report

Poltrona girevole - Swivel armchair







Kruger

Toilette - Dressing table



Kruger

Pouff - Pouffe





Pablo

Letto - Bed







Kruger

Panca - Bench



Eros

Specchio - Mirror



Roger



DIVANO SOFA - SOFA COUCH

00344/P - l. 224 x p. 110 x h. 80 cm
 00344 - l. 266 x p. 110 x h. 80 cm
 00344/G - l. 300 x p. 110 x h. 80 cm

Struttura di base in multistrato di pioppo da 25 mm a doppio spessore rinforzata da profilato in metallo 50x50 di sostegno anteriore incinghiato con nastri elastici di 6 cm. Struttura schienali e braccioli in multistrato di pioppo spessore 18 cm. Struttura di base ingommata con due densità: 30 nelle parti esterne e 70 nelle parti superiori per aumentare il sostegno del rivestimento. Cuscino schienale interno in guscio di cotone antipiroma riempito con miscela mista acrilico e piumino. Cuscini di seduta in poliuretano espanso con doppia densità: 30 portante nella parte frontale e 32 moon p elastico con alta respirabilità nella parte retrostante. Bombatura superiore in 35os rosa ad alta resilienza, il tutto ricoperto con lastra di memory di 3 cm e chiuso da guscio di cotone antipiroma riempito in piumino. Rivestimento cuscini completamente sfoderabile. Basamento in metallo verniciato a polvere ancorato a struttura portante del telaio.

Base structure in 25-mm dual-layered poplar plywood reinforced with 50x50 metal profile, front support fastened with 6-cm elastic belts. Back and armrests structure in 18-cm poplar plywood. Base structure gummed with two densities: 30% for the external parts and 70% for the upper parts to improve the support of the upholstery. Back cushion interior in a down-proof cotton casing stuffed with a combination of acrylic and down filling. Seat cushions padded with expanded polyurethane double density foam: 30% high capacity for the front and 32% moon p elastic with high breathability for the backrest. Upper convexity in high resilience pink 35% os, all covered with a 3-cm memory foam sheet and enclosed in a down-proof cotton casing stuffed with down. Completely removable cushion covers. Base in powder-coated metal anchored to the load-bearing structure of the frame.

PAG.
 6, 14, 15, 16, 17, 18, 19, 21, 23, 30

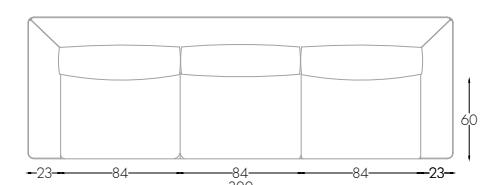
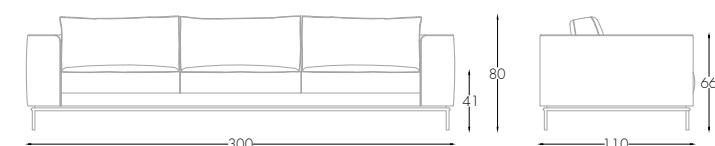
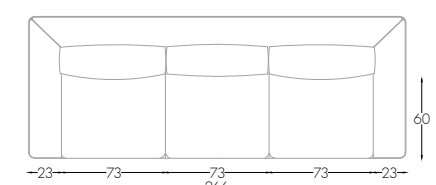
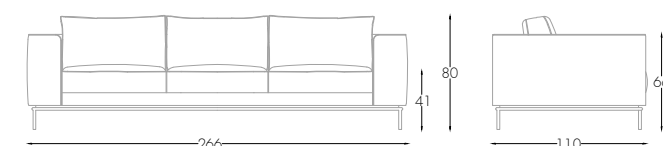
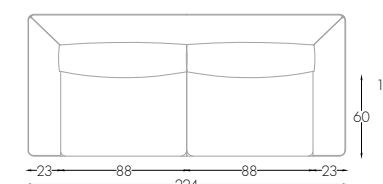
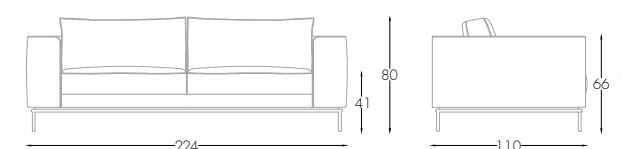

Report

POLTRONA - ARMCHAIR

00331 - l. 89 x p. 83 x h. 80 cm

Struttura schienale in multistrato curvo di pioppo da 18 mm. Struttura sedile in multistrato di abete in spessore 25 incinghiato con nastri elastici di 6 cm. Ingommatura bracciolo parte superiore in 70 portante, tamponatura interna ed esterna in 30 grf, il tutto rivestito con falda acrilica grammatura 100 gr. Imbottitura scocca in poliuretano espanso densità 25 portante il tutto rivestito con falda acrilica grammatura 150 gr. Imbottitura di seduta in poliuretano espanso con doppia densità: 30 portante nella parte frontale e 35 prf elastico nella parte retrostante, il tutto ricoperto con lastra di 2 cm in memory rivestito in falda acrilica 150 gr. Basamento in metallo verniciato a polvere ancorato a struttura portante del telaio.

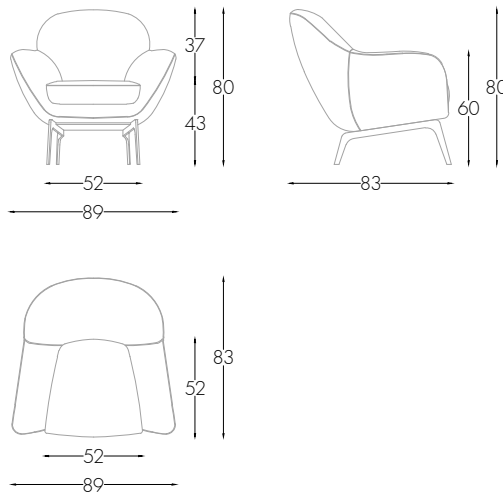

Backrest structure in curved 18-mm poplar plywood. Seat structure in 25-mm fir plywood fastened with 6-cm elastic belts. Upper part armrest gumming in 70% high capacity, internal and externa padding in 30% grf, all lined with a 100-grammage acrylic sheet. Body stuffed with 25 density expanded polyurethane foam, all covered with a 150-grammage acrylic sheet. Seat padding in expanded polyurethane foam with double density: 30% high capacity on the front and 35% elastic-density on the rear, all covered with a 2-cm memory foam encased in a 150-gr. acrylic sheet. Base in powder coated metal anchored to the load-bearing structure of the frame.

PAG.
37, 38, 40, 41

Report

POLTRONA GIREVOLE - SWIVEL ARMCHAIR

00330 - l. 89 x p. 83 x h. 80 cm

Struttura schienale in multistrato curvo di pioppo da 18 mm. Struttura sedile in multistrato di abete in spessore 25 incinghiato con nastri elastici di 6 cm. Ingommatura bracciolo parte superiore in 70 portante, tamponatura interna ed esterna in 30 grf, il tutto rivestito con falda acrilica grammatura 100 gr. Imbottitura scocca in poliuretano espanso densità 25 portante il tutto rivestito con falda acrilica grammatura 150 gr. Imbottitura di seduta in poliuretano espanso con doppia densità: 30 portante nella parte frontale e 35 prf elastico nella parte retrostante, il tutto ricoperto con lastra di 2 cm in memory rivestito in falda acrilica 150 gr. Basamento in metallo verniciato a polvere ancorato a struttura portante del telaio. Meccanismo girevole con molla di ritorno.

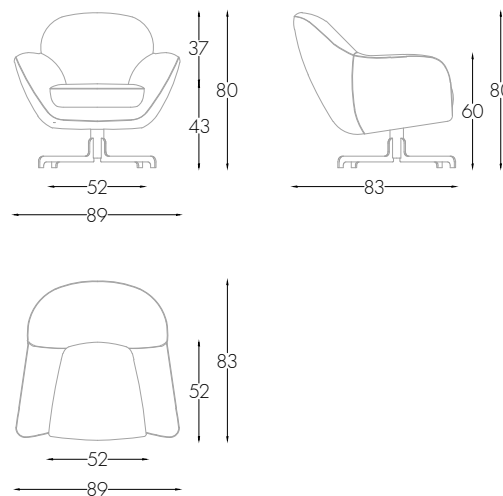

Backrest structure in curved 18-mm poplar plywood. Seat structure in 25-mm fir plywood fastened with 6-cm elastic belts. Upper part armrest gumming in 70% high capacity, internal and externa padding in 30% grf, all lined with a 100-grammage acrylic sheet. Body stuffed with 25 density expanded polyurethane foam, all covered with a 150-grammage acrylic sheet. Seat padding in expanded polyurethane foam with double density: 30% high capacity on the front and 35% elastic-density on the rear, all covered with a 2-cm memory foam encased in a 150-gr. acrylic sheet. Base in powder coated metal anchored to the load-bearing structure of the frame. Swivel mechanism with return system.

PAG.
43, 44, 47



Report Bergere

POLTRONA - ARMCHAIR

00328 - l. 89 x p. 100 x h. 96 cm

Struttura schienale in multistrato curvo di pioppo da 18 mm. Struttura sedile in multistrato di abete in spessore 25 incinghiato con nastri elastici di 6 cm. Ingommatura bracciolo parte superiore in 70 portante, tamponatura interna ed esterna in 30 grf, il tutto rivestito con falda acrilica grammatura 100 gr. Imbottitura scocca in poliuretano espanso densità 25 portante, il tutto rivestito con falda acrilica grammatura 150 gr. Imbottitura di seduta in poliuretano espanso con doppia densità: 30 portante nella parte frontale e 35 prf elastico nella parte retrostante, il tutto ricoperto con lastra di 2 cm in memory rivestito in falda acrilica 150 gr. Basamento in metallo verniciato a polvere ancorato a struttura portante del telaio.

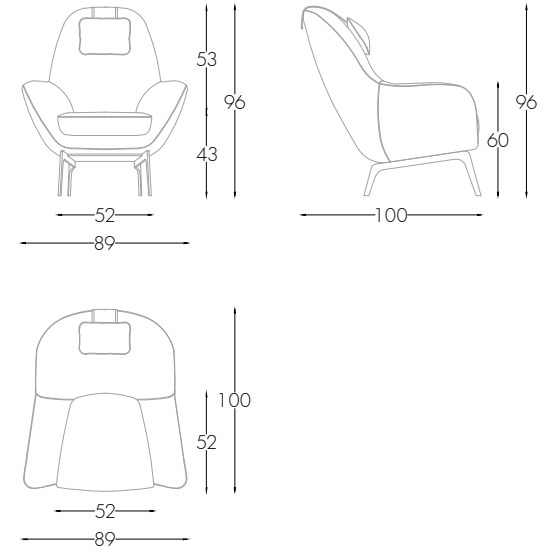

Backrest structure in curved 18-mm poplar plywood. Seat structure in 25-mm fir plywood fastened with 6-cm elastic belts. Upper part armrest gumming in 70% high capacity, internal and external padding at 30% grf, all encased in a 100-gr. acrylic sheet. Body stuffing in 25% high capacity density expanded polyurethane foam, all encased in a 150-gr. acrylic sheet. Seat stuffed in polyurethane foam with double density: 30% high capacity density on the front and 35% elastic-density on the rear, all covered with a 2-cm sheet in memory foam encased in a 150-gr. acrylic sheet. Base in powder-coated metal anchored to the load-bearing structure of the frame.

PAG.
32, 33, 34, 35

Report Bergere

POLTRONA GIREVOLE - SWIVEL ARMCHAIR

00329 - l. 89 x p. 100 x h. 96 cm

Struttura schienale in multistrato curvo di pioppo da 18 mm. Struttura sedile in multistrato di abete in spessore 25 incinghiato con nastri elastici di 6 cm. Ingommatura bracciolo parte superiore in 70 portante, tamponatura interna ed esterna in 30 grf, il tutto rivestito con falda acrilica grammatura 100 gr. Imbottitura scocca in poliuretano espanso densità 25 portante, il tutto rivestito con falda acrilica grammatura 150 gr. Imbottitura di seduta in poliuretano espanso con doppia densità: 30 portante nella parte frontale e 35 prf elastico nella parte retrostante, il tutto ricoperto con lastra di 2 cm in memory rivestito in falda acrilica 150 gr. Basamento in metallo verniciato a polvere ancorato a struttura portante del telaio. Meccanismo girevole con molla di ritorno.

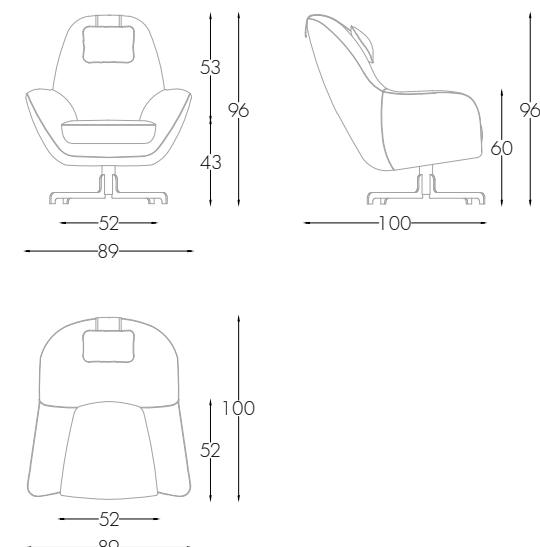

Backrest structure in curved 18-mm poplar plywood. Seat structure in 25-mm fir plywood fastened with 6-cm elastic belts. Upper part armrest gumming in 70% high capacity, internal and external padding at 30% grf, all encased in a 100-gr. acrylic sheet. Body stuffing in 25% high capacity density expanded polyurethane foam, all encased in a 150-gr. acrylic sheet. Seat stuffed in polyurethane foam with double density: 30% high capacity density on the front and 35% elastic-density on the rear, all covered with a 2-cm sheet in memory foam encased in a 150-gr. acrylic sheet. Base in powder-coated metal anchored to the load-bearing structure of the frame. Swivel mechanism with return system.

PAG.
7, 29, 31



Report

POUFF - POUFFE

00332 - l. 62 x p. 62 x h. 35 cm

Struttura di base in multistrato di pioppo da 25 mm imbottito in poliuretano espanso doppia densità, parte inferiore in 30 portante, parte superiore e bombatura in 35 elastico, tutto ricoperto con memory spessore 2 cm. Rivestito in falda acrilica 150 g. Rivestimento fisso non sfoderabile. Basamento in metallo verniciato a polvere ancorato a struttura portante del telaio.

Base structure in 25-mm poplar plywood stuffed with expanded double density polyurethane foam, lower part with 30% high capacity, upper part and convexity with 35% elastic, all wrapped in a 2-cm thick memory foam sheet. Encased in a 150-gr. acrylic sheet. Non-removable fixed cover. Base in powder-coated metal anchored to the load-bearing structure of the frame.

PAG.
30, 42, 47

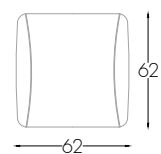
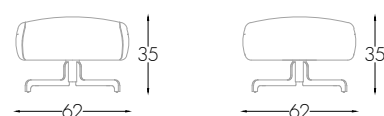

Kruger

TAVOLINO - SIDE TABLE

00351 - l. 45 x p. 45 x h. 35 cm

Struttura gambe e piano in MDF lavorato a controllo per ottenere le sagome di forma da progetto Tutto laccato con finitura lucida a poliestere. Dettagli in ottone satinato.

Legs structure and top in MDF worked with numerical control processing to obtain the designed shape. All lacquered with glossy polyester finish. Details in satin brass.

PAG.
22, 23, 57

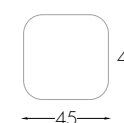
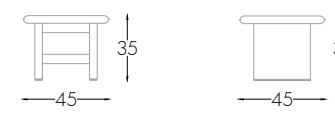

Russell

POUFF - POUFFE

00352 - l. 90 x p. 90 x h. 43 cm

Struttura in multistrato di abete, imbottito in poliuretano espanso densità 30 elastico parte superiore 30 portante perimetro esterno. Bombatura in poliuretano 35 elastico, il tutto rivestito in falda acrilica 150 g. Rivestimento con lavorazione con filetto su perimetro superiore non sfoderabile.

Fir plywood structure, stuffed with 30% density expanded polyurethane foam on the upper part and 30% high capacity density on the external perimeter. Convexity in elastic 35% density polyurethane, all encased in a 150-gr. acrylic sheet. Non-removable upholstery, with thread trims on upper perimeter.

PAG.
20

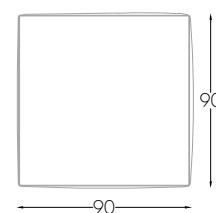
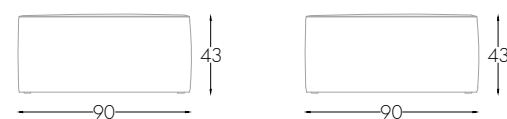

Kruger

PANCA - BENCH

00337 - l. 150 x p. 45 x h. 43 cm

Struttura gambe e piano in MDF lavorato a controllo per ottenere le sagome di forma da progetto Tutto laccato con finitura lucida a poliestere. Cuscino in appoggio in poliuretano espanso densità 30 elastico con rivestimento in falda acrilica. Rivestito in tessuto pelle con piano inferiore con antiscivolo. Rivestimento sfoderabile. Dettagli in ottone satinato.

Legs structure and seat in MDF worked with numerical control processing to obtain the designed shape. All lacquered with glossy polyester finish. Support cushion in 30% elastic-density expanded polyurethane foam and encased in an acrylic sheet. Non-removable upholstery in fabric or leather. Details in satin brass.

PAG.
6, 7, 56, 58, 59, 60, 61

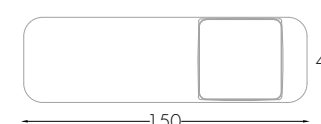
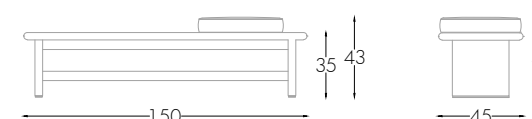

Kruger

CONSOLLE - CONSOLE

00340 - l. 142 x p. 47 x h. 77 cm

Struttura superiore in multistrati di pioppo di spessore 18 mm. Interno cassetti in multistrati di betulla rivestiti in tessuto. Struttura gambe in MDF lavorato a controllo per ottenere le sagome di forma da progetto. Tutto laccato con finitura lucida a poliestere. Piano top in MDF lavorato e calibrato per spessore controbilanciato e verniciato con finitura lucida. Struttura superiore imbottita con poliuretano espanso densità 30 portante. Dettagli in ottone satinato.

Upper structure in 18-mm poplar plywood. Internal drawers in birch plywood lined in fabric. Legs structure in MDF worked with numerical control processing to obtain the designed shape. All lacquered with glossy polyester finish. Top surface in MDF processed and calibrated for offset thickness and coated with a glossy finish. Upper structure stuffed with 30% high capacity density expanded polyurethane foam. Lift-top in smoke-grey tempered glass. Details in satin brass.

PAG.
25, 26, 27

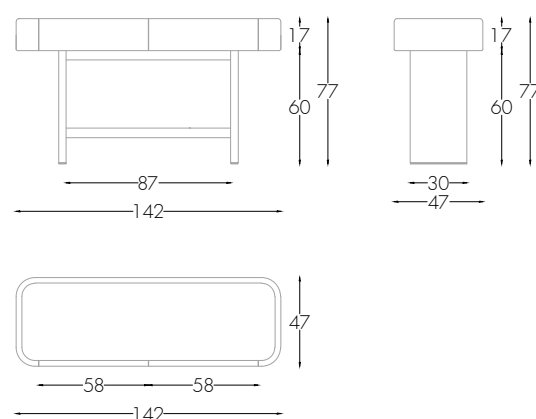

Kruger

CONSOLLE - CONSOLE

00341 - l. 142 x p. 47 x h. 87 cm

Struttura superiore in multistrati di pioppo di spessore 18 mm. Interno cassetti in multistrati di betulla rivestiti in tessuto. Struttura gambe in MDF lavorato a controllo per ottenere le sagome di forma da progetto. Tutto laccato con finitura lucida a poliestere. Piano top in MDF lavorato e calibrato per spessore controbilanciato e verniciato con finitura lucida. Struttura superiore imbottita con poliuretano espanso densità 30 portante. Alzatina in cristallo fumè temperato. Dettagli in ottone satinato.

Upper structure in 18-mm poplar plywood. Internal drawers in birch plywood covered in fabric. Legs structure in MDF worked with numerical control processing to obtain the designed shape. All lacquered with glossy polyester finish. Top surface in MDF processed and calibrated for offset thickness and coated with glossy finish. Upper structure padded with 30% high capacity density expanded polyurethane foam. Lift-top in smoke-grey tempered crystal glass. Details in satin brass.

PAG.
5, 6, 7, 8, 10, 11

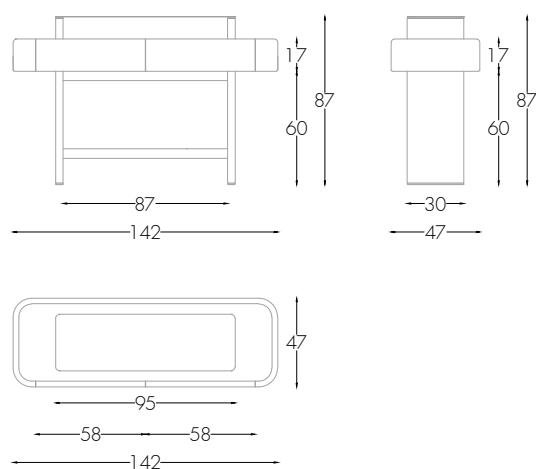

Kruger

TOILETTE - DRESSING TABLE

00338 - l. 142 x p. 47 x h. 115 cm

Struttura superiore in multistrati di pioppo di spessore 18 mm. Interno cassetti in multistrati di betulla rivestiti in tessuto. Struttura gambe in MDF lavorato a controllo per ottenere le sagome di forma da progetto. Tutto laccato con finitura lucida a poliestere. Piano top in MDF lavorato e calibrato per spessore controbilanciato e verniciato con finitura lucida. Struttura superiore imbottita con poliuretano espanso densità 30 portante. Specchio imperniato su supporto girevole in ottone satinato, retroilluminazione a led con sensore di movimento per accensione/spegnimento. Dettagli in ottone satinato.

Upper structure in 18-mm poplar plywood. Internal drawers in birch plywood lined in fabric. Legs structure in MDF worked with numerical control processing to obtain the designed shape. All lacquered with glossy polyester finish. Top surface in MDF processed and calibrated for offset thickness and coated with glossy finish. Upper structure padded with 30% high capacity density expanded polyurethane foam. Mirror hinged on a swivel support in satin brass, LED backlighting with on/off movement sensor switch. Details in satin brass.

PAG.
49, 51, 52, 53

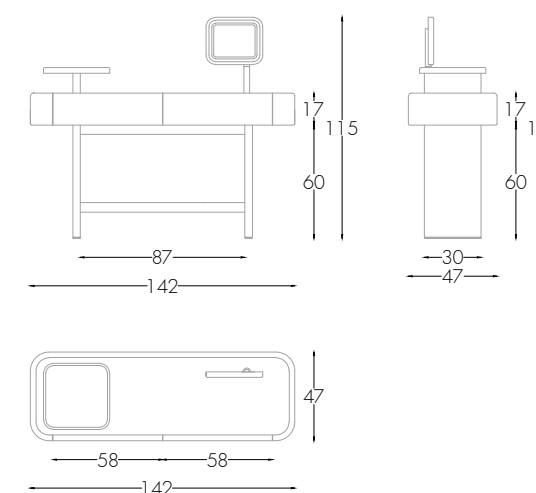

Kruger

POUFF - POUFFE

00339 - l. 47 x p. 47 x h. 47 cm

Struttura gambe in MDF lavorato a controllo per ottenere le sagome di forma da progetto. Tutto laccato con finitura lucida a poliestere. Cuscino seduta fisso in multistrato di pioppo da 25 mm in poliuretano espanso densità 30 elastico con rivestimento in falda acrilica. Rivestito in tessuto o pelle non sfoderabile. Dettagli in ottone satinato.

Legs structure in MDF worked with numerical control processing to obtain the designed shape. All lacquered with glossy polyester finish. Seat cushion fixed on 25-mm poplar plywood and stuffed with 30% elastic-density expanded polyurethane foam and encased in an acrylic sheet. Upholstered in non-removable fabric or leather. Details in satin brass.

PAG.
49, 50

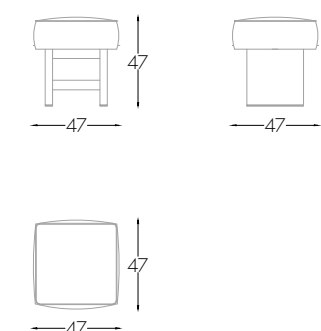

Eros

SPECCHIO - MIRROR

00333 - l. 80 x p. 5 x h. 80 cm

Struttura in MDF lavorato a controllo per ottenere sagome di forma come da progetto. Tutto laccato con finitura lucida a poliestere. Retroilluminazione a led a luce fredda con sensore a sfioro per accensione. Trasformatore adattabile per qualsiasi voltaggio di alimentazione con range da 100/240 v. Specchi incollati su pannello di MDF senza pellicola protettiva.

Structure in MDF worked with numerical control processing to obtain the designed shape. All lacquered with glossy polyester finish. Cold LED backlight with touch sensor switch. Transformer adaptable for any voltage with a range of 100/240 v. Mirrors glued on MDF panel without protective film.

PAG.
5, 6, 7, 8, 13

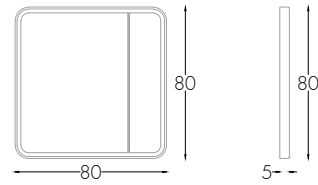

Eros

SPECCHIO - MIRROR

00335 - l. 180 x p. 5 x h. 180 cm

Struttura in MDF lavorato a controllo per ottenere sagome di forma come da progetto. Tutto laccato con finitura lucida a poliestere. Retroilluminazione a led a luce fredda con sensore a sfioro per accensione. Trasformatore adattabile per qualsiasi voltaggio di alimentazione con range da 100/240 v. Specchi incollati su pannello di MDF senza pellicola protettiva.

Structure in MDF worked with numerical control processing to obtain the designed shape. All lacquered with glossy polyester finish. Cold LED backlight with touch sensor switch. Transformer adaptable for any voltage with a range of 100/240 v. Mirrors glued on MDF panel without protective film.

PAG.
46, 47

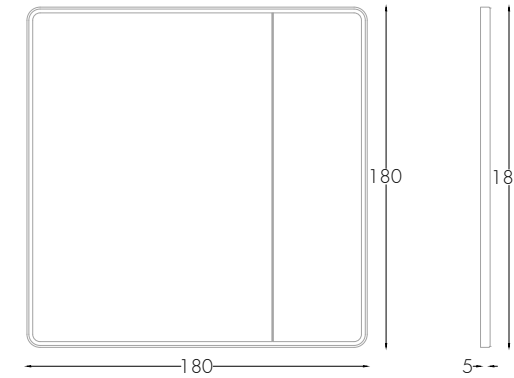

Eros

SPECCHIO - MIRROR

00334 - l. 80 x p. 5 x h. 180 cm

Struttura in MDF lavorato a controllo per ottenere sagome di forma come da progetto. Tutto laccato con finitura lucida a poliestere. Retroilluminazione a led a luce fredda con sensore a sfioro per accensione. Trasformatore adattabile per qualsiasi voltaggio di alimentazione con range da 100/240 v. Specchi incollati su pannello di MDF senza pellicola protettiva.

Structure in MDF worked with numerical control processing to obtain the designed shape. All lacquered with glossy polyester finish. Cold LED backlight with touch sensor switch. Transformer adaptable for any voltage with a range of 100/240 v. Mirrors glued on MDF panel without protective film.

PAG.
62, 63

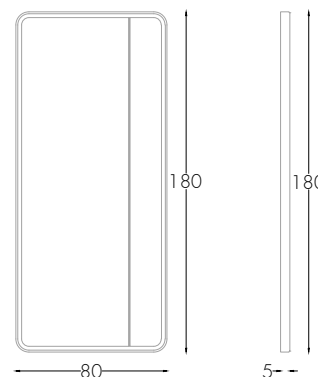

Pablo

LETTO - BED

00183/P - l. 200 x p. 222 x h. 160 cm

Struttura in multistrati, imbottita con gomme di varie densità, fissaggi con squadre in acciaio verniciate. Testata con lavorazione a doghe verticali, piping in pelle. Predisposto per rete in appoggio. Rivestimento in tessuto o pelle.

Plywood structure, padded with multi-density rubbers, steel painted bracket fasteners. Headboard with piping in leather. Ready to support bedbase. Upholstery in fabric or leather.

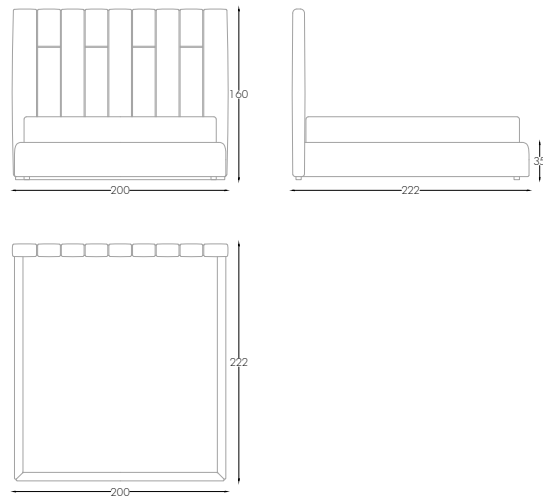

Tessuti per paralumi
Lamp shade fabrics



RASO ECRÙ

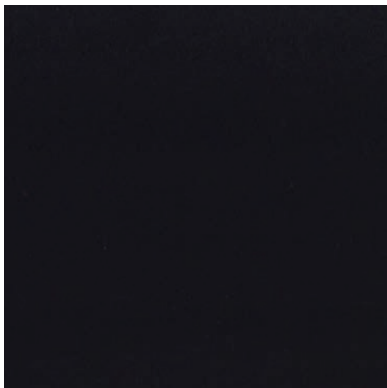

RASO NERO



LINO

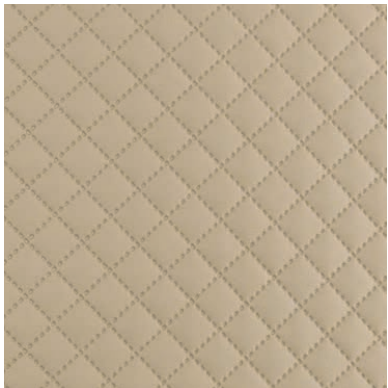

ECOPELLE SABBIA



ECOPELLE MOKA

Legno a trama ondulata
Wavy pattern wood



FOGLIA ORO PATINATA LUCIDA
GLOSSY COATED GOLD LEAF



FINITURA LUCIDA EFFETTO TITANIO
GLOSSY TITANIUM EFFECT
FINISHING

Essenze
Wood finishes

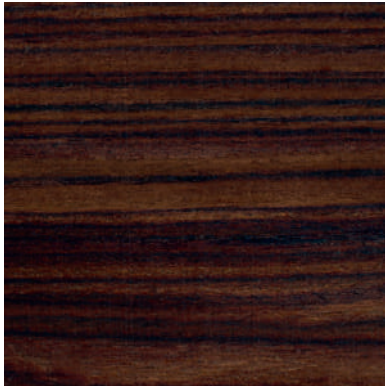

NOCE DARK GLOSSY

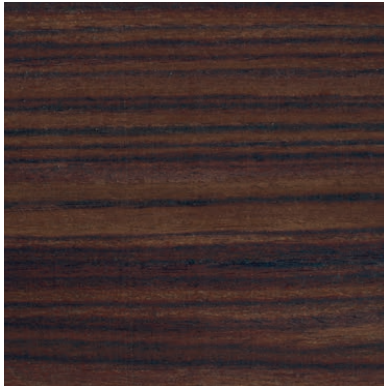

NOCE DARK MATT



MIRTO GLOSSY



MIRTO MATT



MIRTO GREY



EBONY

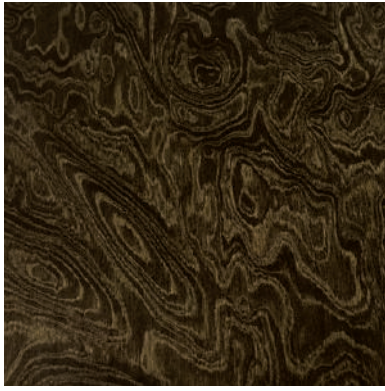

MIRTO NERO

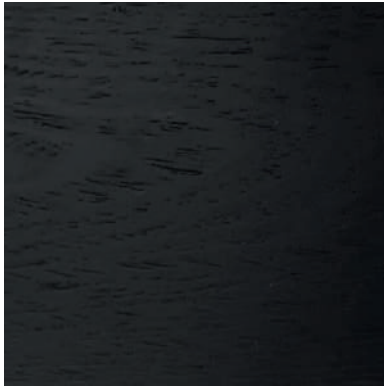

FRASSINO NERO PORO APERTO

Laccati
Lacquered finishes



LONDRA



MIAMI

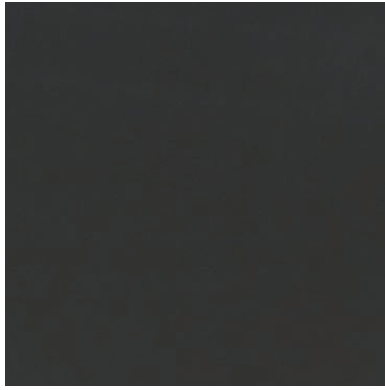

TOKYO



AVORIO

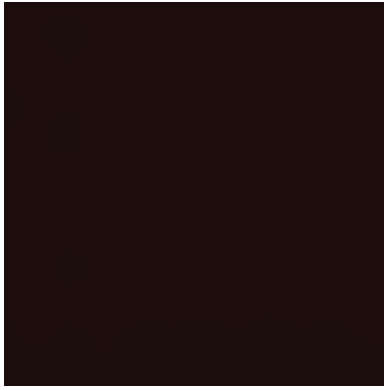

FUMO

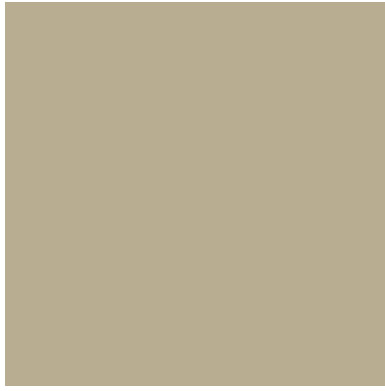

CANAPA

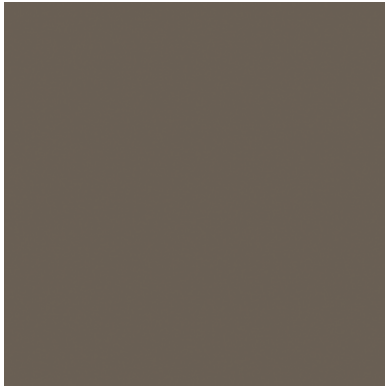

VISONE



POSITANO

Vetri, specchi e metalli

Glasses, mirrors and metals

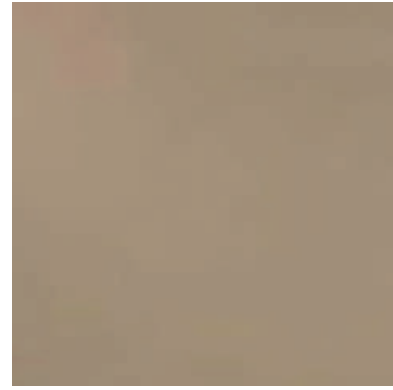

VETRO BRONZO - BRONZE GLASS



SPECCHIO BRONZO - BRONZE MIRROR

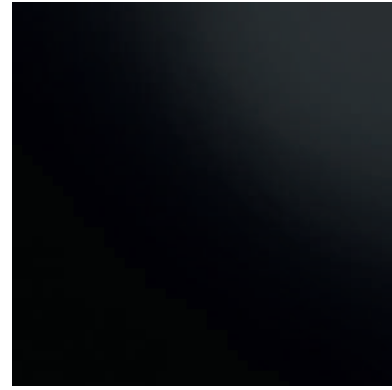

VETRO LACCATO NERO - LAQUERED BLACK GLASS

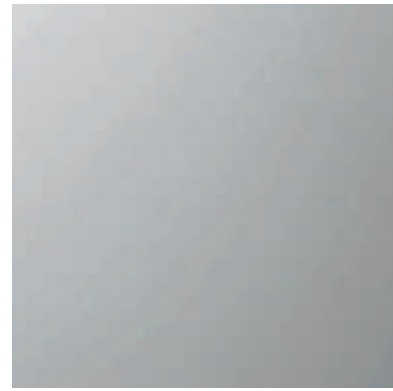

VETRO FUMÈ - SMOKED GLASS



SPECCHIO FUMÈ - SMOKED MIRROR



OTTONE FINITURA TITANIO - BRASS WITH TITANIUM FINISHING



OTTONE BRUNITO - BURNISHED BRASS



OTTONE SATINATO - SATIN BRASS

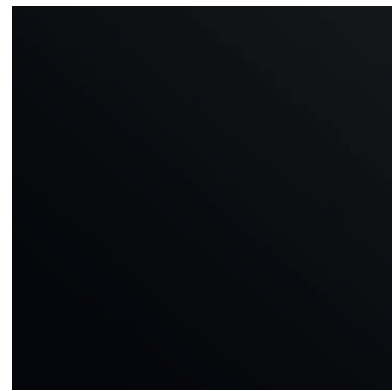

ACCIAIO LACCATO NERO OPACO - LAQUERED INOX BLACK MATT

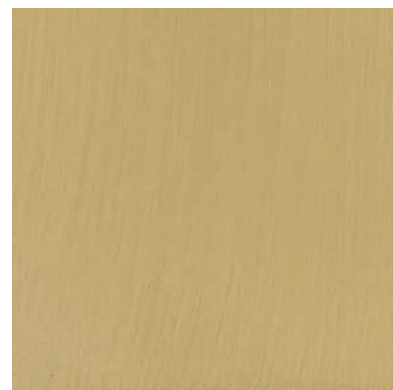

BRASS PAINT



CHAMPAGNE PAINT



OXID PAINT

Tessuti

Fabrics

Cat. A



SAILOR 01 SABBIA



SAILOR 09 BLU



SAILOR 11 NATURALE



SAILOR 46 MOKA

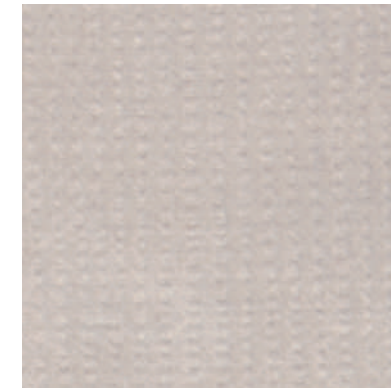

SAILOR 121 GHIACCIO



SAILOR 165 MARMOTTA



SAILOR 429 VERDE



SAILOR 435 BOSCO

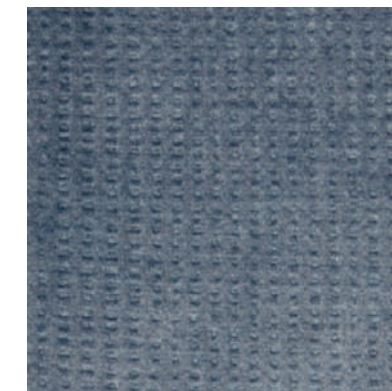

SAILOR 705 JEANS

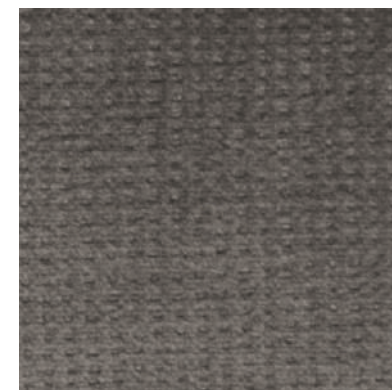

SAILOR 740 TORTORA



SAILOR 1670 CORALLO

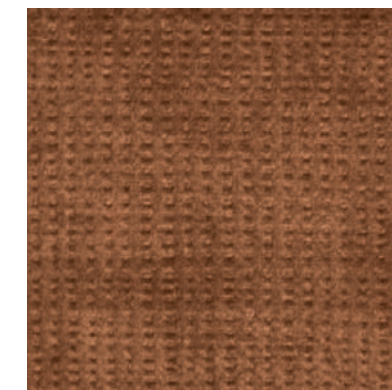

SAILOR 1898 TERRACOTTA



MOON LIGHT 104 CANAPA



MOON LIGHT 10 PORTOFINO



MOON LIGHT 14 AVIO



MOON LIGHT 20 TORTORA



MOON LIGHT 04 CAMMELLO



MOON LIGHT 03 DUNE



MOON LIGHT 11 VISONE



MOON LIGHT 100 CIOCCOLATO



MOON LIGHT 18 NERO

Tessuti Fabrics

Cat. B

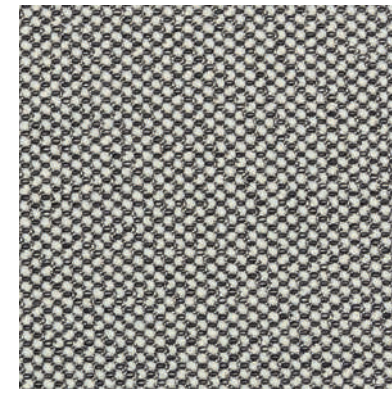

VENICE 01 SALEPEPE



VENICE 02 WHITE



VENICE 05 SAND

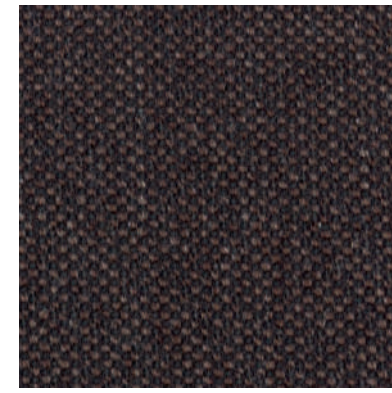

VENICE 07 MOKA

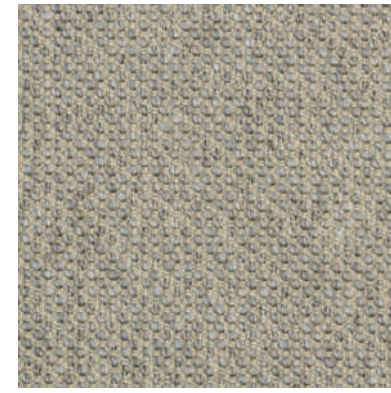

VENICE 08 TORTORA

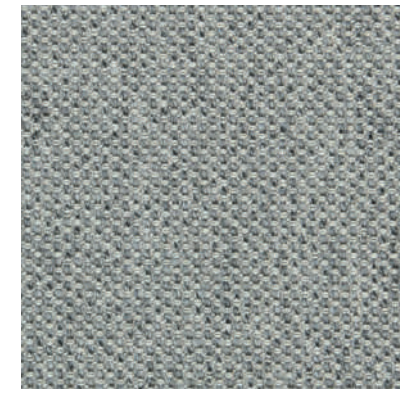

VENICE 09 SILVER

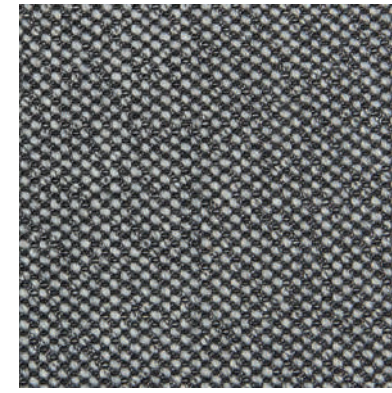

VENICE 11 GLACEE

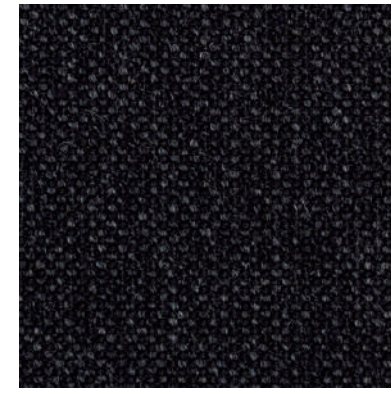

VENICE 12 LONDRA

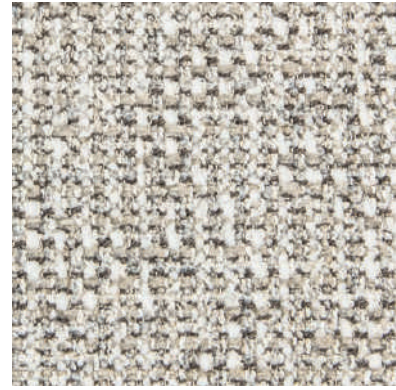

RITZ 02 SABBIA



RITZ 03 BEIGE

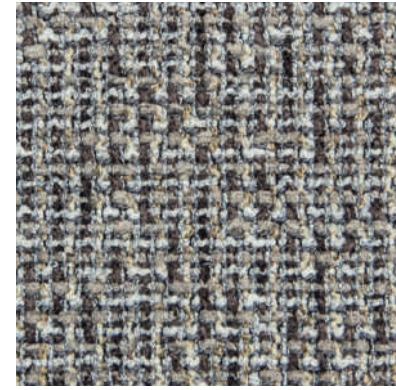

RITZ 04 GREIGE



RITZ 05 GREY

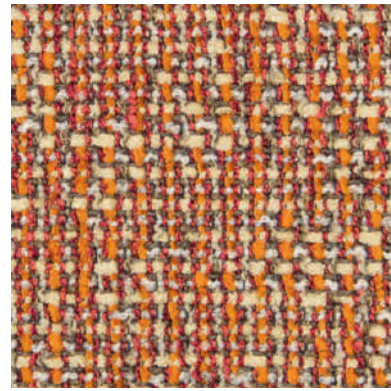

RITZ 08 RED

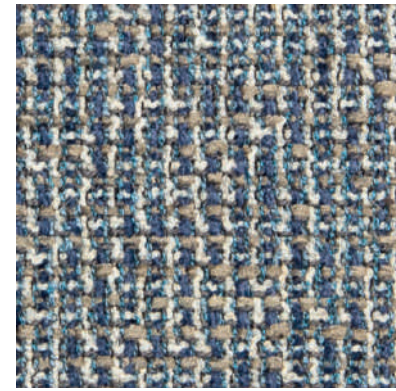

RITZ 09 BLU

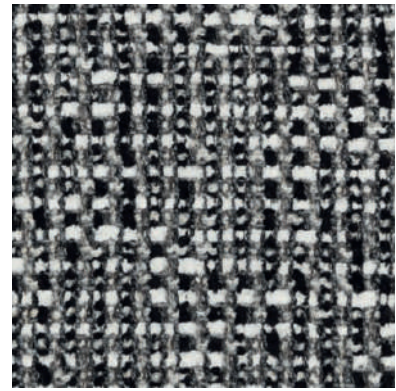

RITZ 12 SALEPEPE

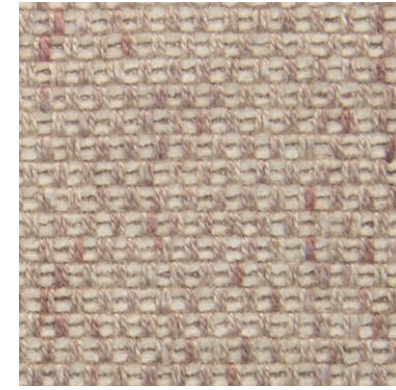

INFINITY 01 NATURALE

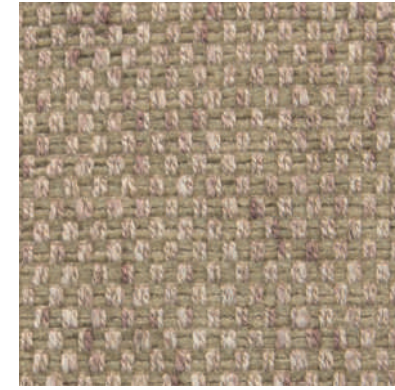

INFINITY 02 SACCO

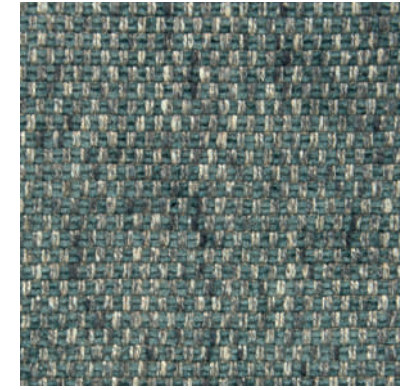

INFINITY 14 PETROLIO

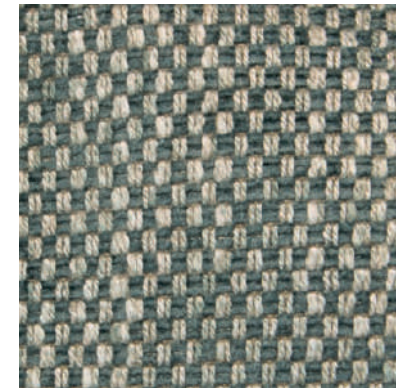

INFINITY 15 FELCE

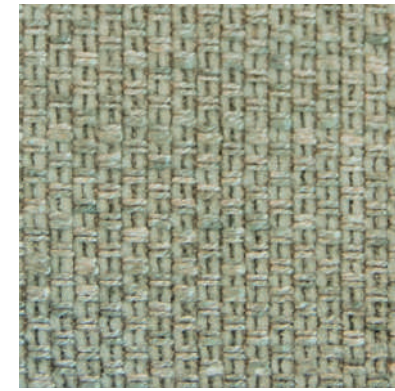

INFINITY 16 SALVIA

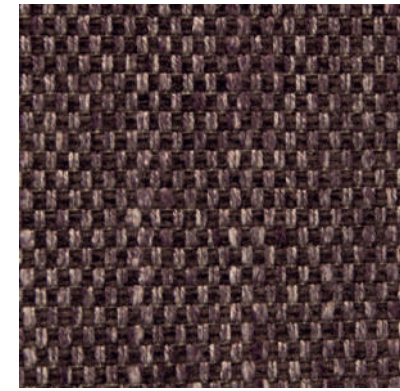

INFINITY 18 MORO



ANGEL 10 NATURALE



ANGEL 13 SABBIA



ANGEL 14 ARMY



ANGEL 26 LORD



LULY 02 GESSO

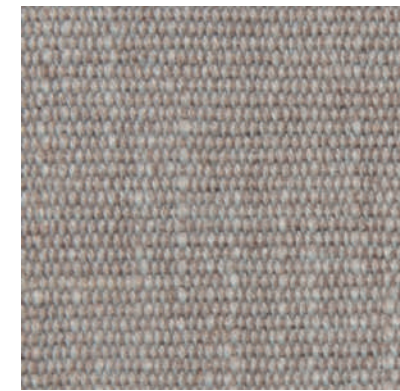

LULY 05 ARGENTO



LULY 06 CENERE



LULY 09 MOKA



LULY 10 VISIONE



LULY 14 CIELO



LULY 22 BEIGE



LULY 31 ANTRACITE



LULY 36 OCRA

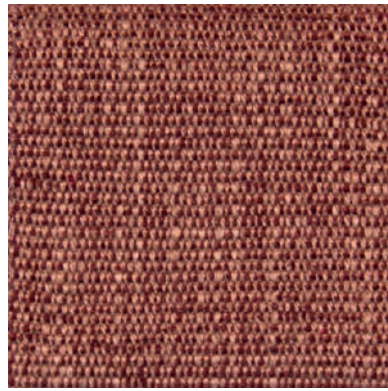

LULY 38 BORDEAUX

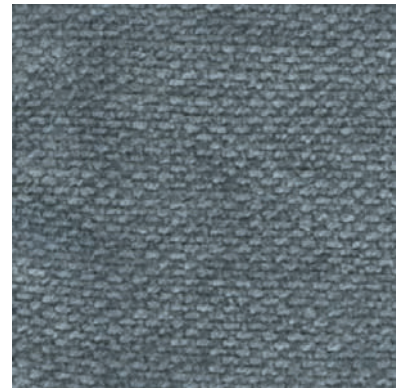

HAVANA 17 AVIO



HAVANA 205 ANTRACITE



HAVANA 1 BEIGE



HAVANA 12 TORTORA



HAVANA 622 CRETA



HAVANA 2 FANGO

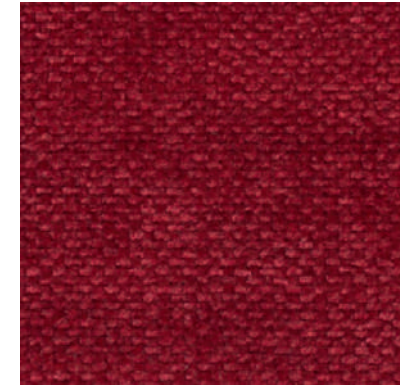

HAVANA 10 ROSSO



NICE 113 CONCHIGLIA



NICE 121 SABBIA



NICE 127 ARDESIA



OLIVER 58 NAVY



OLIVER 1405 VINO



OLIVER 1406 AVIO



OLIVER 2003 GRIGIO



OLIVER 23 SABBIA



OLIVER 05 CASTAGNA



OLIVER 2012 MARMOTTA



OLIVER 2002 MOKA



OLIVER 14 ZUCCA

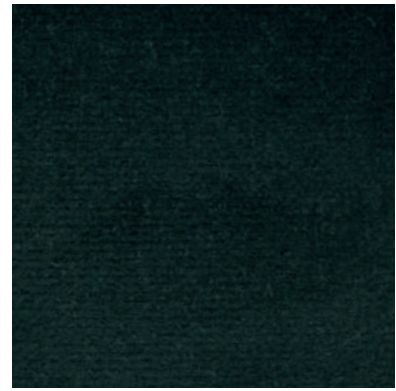

OLIVER 1402 MUSCHIO

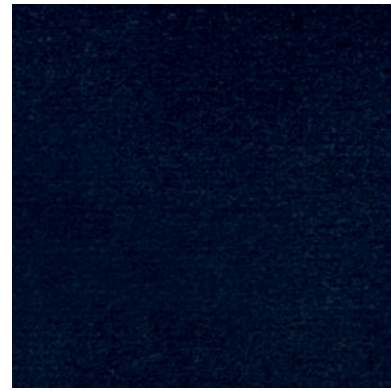

OLIVER 54 COBALTO

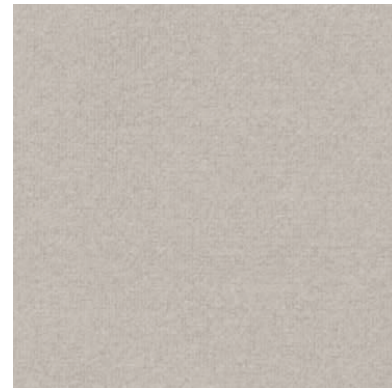

OLIVER 29 GHIACCIO



OLIVER 1404 GHISA

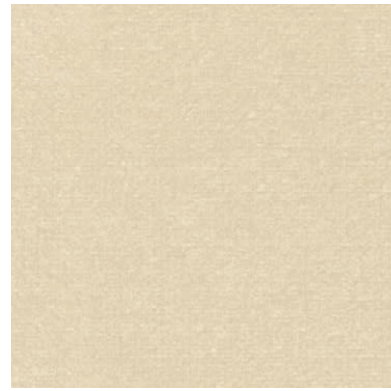

VELVET 02 PANNA

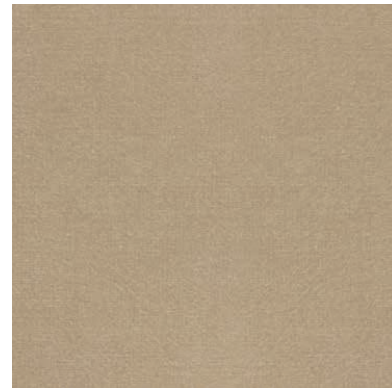

VELVET 1720 BEIGE

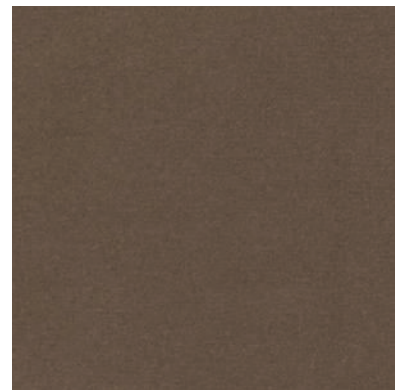

VELVET 1709 MILITARE



VELVET 1715 GAMMELLO

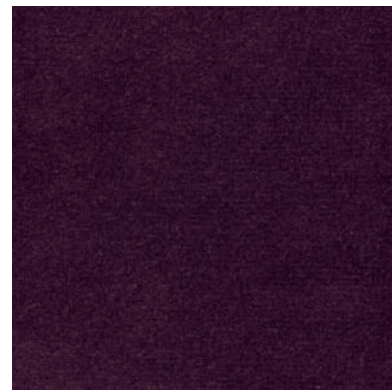

VELVET 09 MELANZANA



VELVET 04 CRETA



VELVET 08 CIOCCOLATO



VELVET 12 PRUSSIA



VELVET 11 GRIGIO



VELVET 1708 TERRA



VELVET 28 MATTONE



VELVET 35 CIPRIA

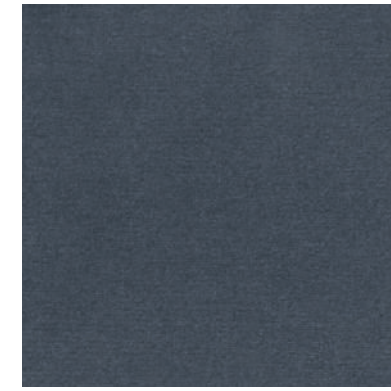

VELVET 111 CARTA DA ZUCCHERO



VELVET 1004 SENAPE

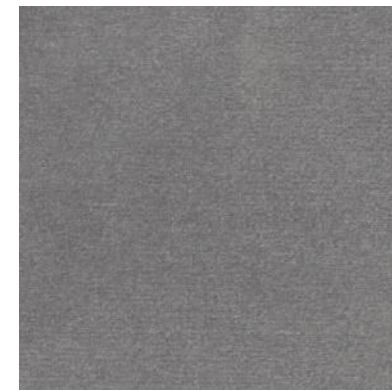

VELVET 19 CROMO

Pelli
Leathers

Cat. A1



SYDNEY 610 BLACK



SYDNEY 615 COTTO



SYDNEY 631 GRAFITE



SYDNEY 651 SABBIA



SYDNEY 682 GHIACCIO



SYDNEY 692 TESTA DI MORO

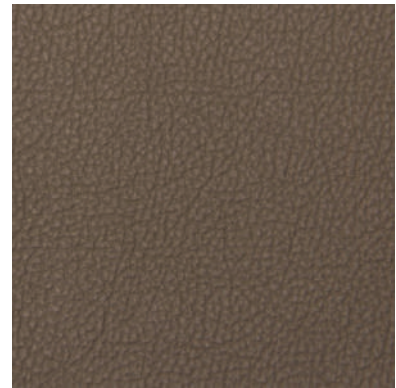

SYDNEY TORTORA

Pelli
Leathers

Cat. A



CLAYTON 1660 GRIGIO



CLAYTON 1639 LUMIERE



CLAYTON 1627 TORTORA



CLAYTON 1101 NERO



CLAYTON 1108 CHIANTI



CLAYTON 1147 DARK



CLAYTON 1179 GESSO



CLAYTON 1216 FANGO



CLAYTON 1226 BEIGE



MIAMI 01 GESSO



MIAMI 03 NATURALE

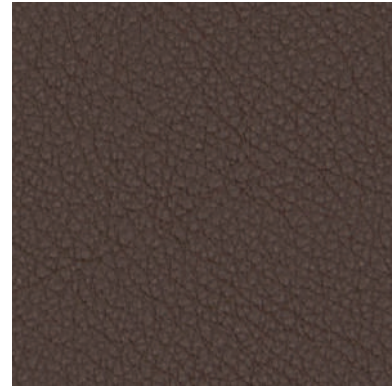

MIAMI 06 FANGO

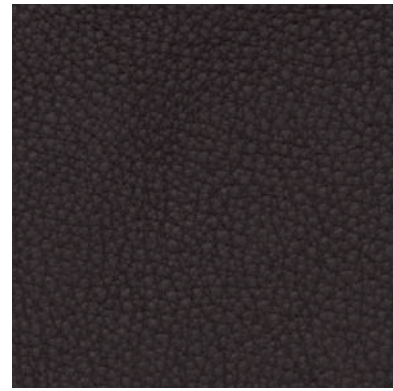

MIAMI 07 TESTA DI MORO

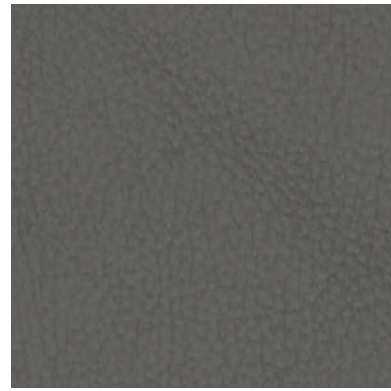

MIAMI 11 TORTORA



MIAMI 13 PIOMBO



BALI 02 COTTO



BALI 17 TABACCO

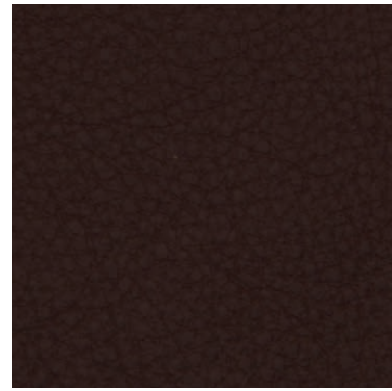

BALI 04 TESTA DI MORO



BALI 07 BLACK



BALI 10 SABBIA

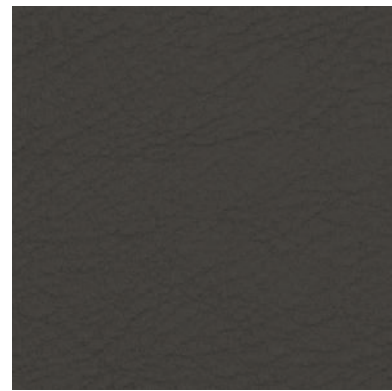

BALI 11 FUMO



BALI 15 GREIGE

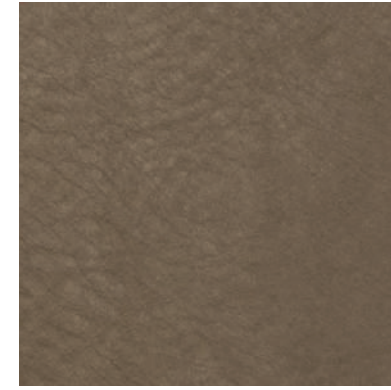

CAMOSCIO 8 FANGO

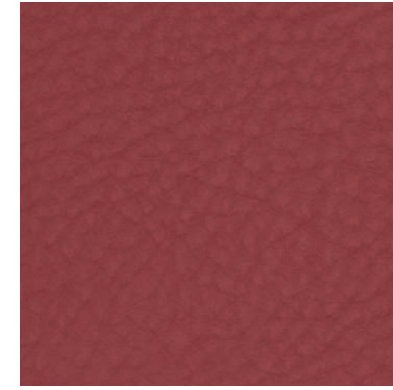

CAMOSCIO 16 PORTOFINO



CAMOSCIO 21 NAMIBIA



CAMOSCIO 23 DUNE



CAMOSCIO 26 GRIGIO



CAMOSCIO 31 PERLA

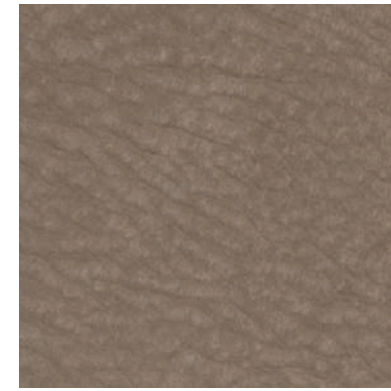

CAMOSCIO 27 TORTORA



CAMOSCIO 32 CORDA

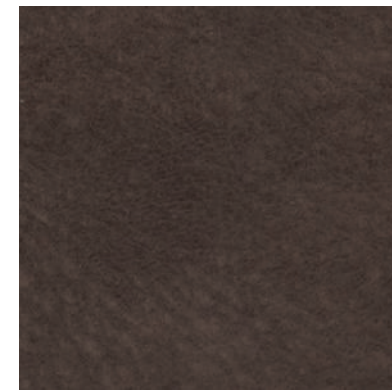

CAMOSCIO 34 MOKA



DELUXE 01 NERO

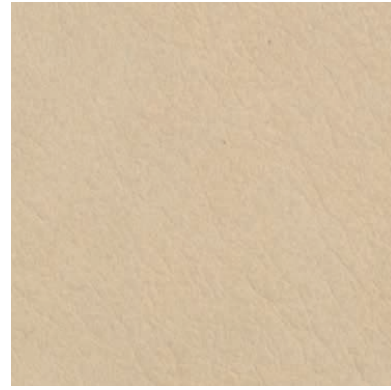

DELUXE 03 CREAM



DELUXE 05 DUNE



DELUXE 08 GREIGE



DELUXE 09 ARDESIA



DELUXE 18 STONE



DELUXE 21 TERRA



DELUXE 22 BROWN



DELUXE 23 ARGILLA



DELUXE 24 GESSO

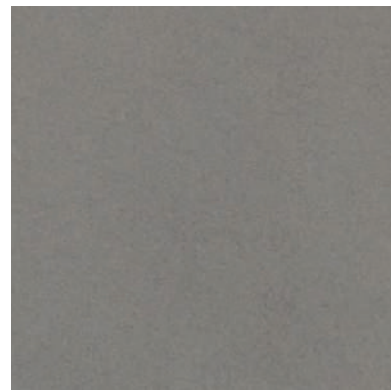

DELUXE 25 CEMENTO

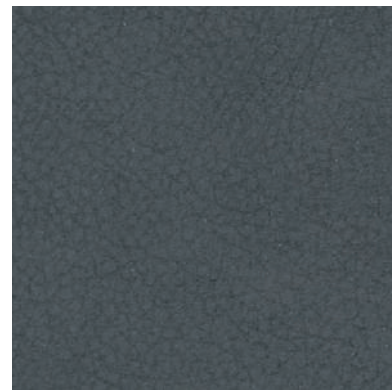

NABUK 2117 FERRO

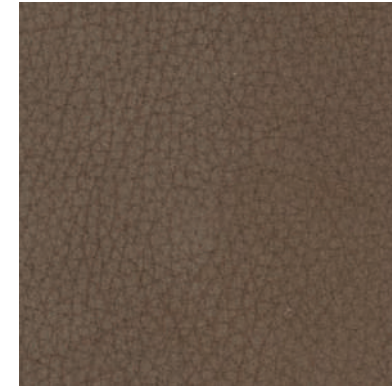

NABUK 2116 TABACCO

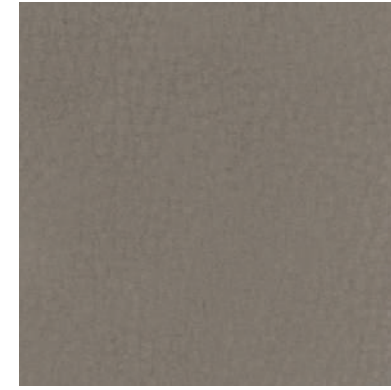

NABUK 2115 TORTORA

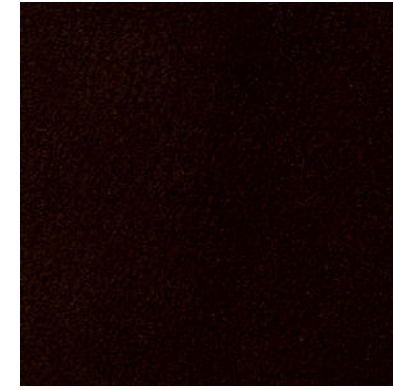

NABUK 2114 CIOCCOLATO



NABUK 2100 GESSO



NABUK 2101 SABBIA



NABUK 2118 CANAPA

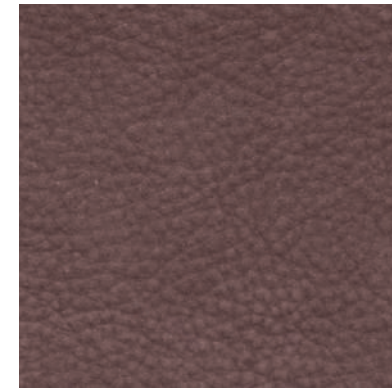

NABUK 10 ROSA ANTICO

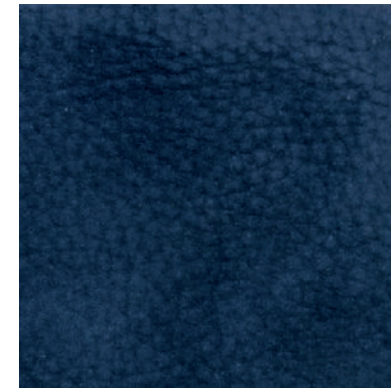

NABUK 18 BLU

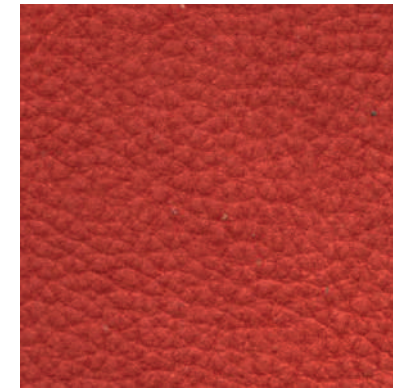

NABUK 21 ROSSO

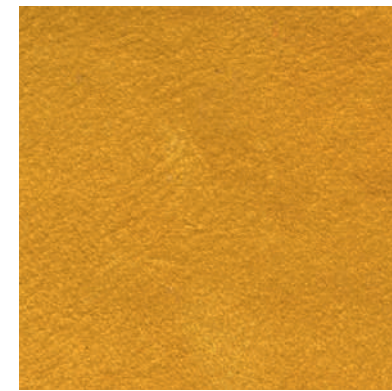

NABUK 22 OCRA

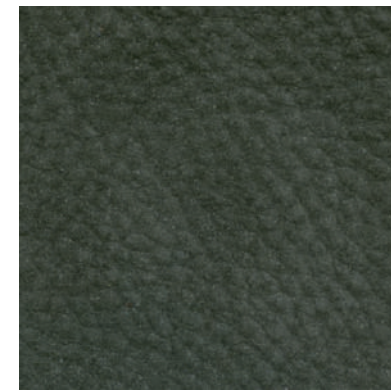

NABUK 24 MUSCHIO

Cuoio Leather

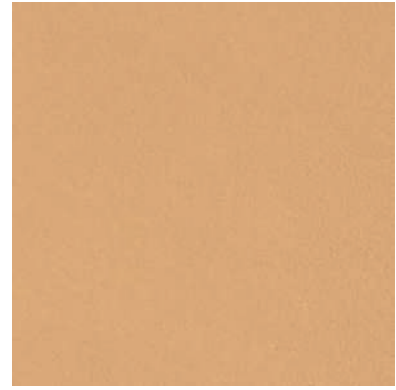

CUOIO BEIGE

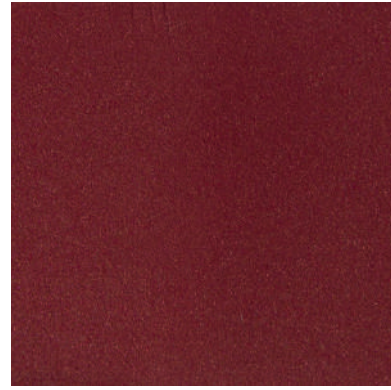

CUOIO BORDEAUX



CUOIO GRIGIO

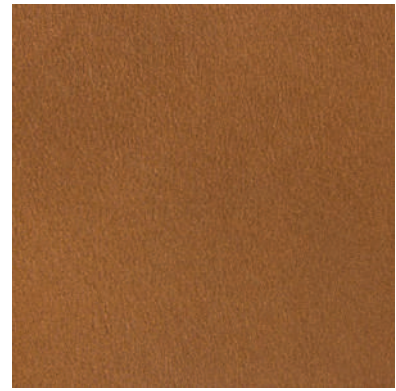

CUOIO INVECCHIATO



CUOIO NERO



CUOIO TESTA DI MORO

Stampe Embossed leather

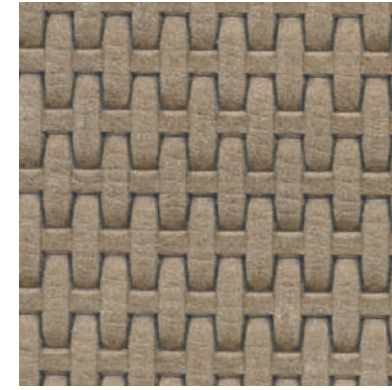

F/11 STAMPA JUBILÉÉ



F/10 STAMPA KORDA

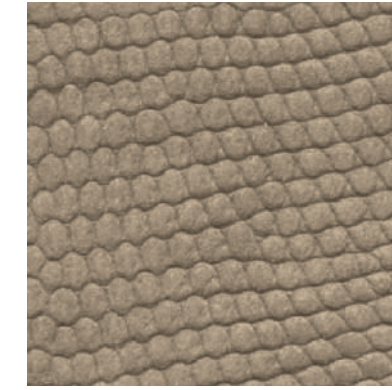

STAMPA KUBA

ESEMPI DI STAMPA RIPRODUCIBILI
SU TUTTO IL CAMPIONARIO PELLE,
NABUK E CAMOSCIO.

SAMPLES OF PRINTS
REPRODUCIBLE ON
ALL KIND OF LEATHER, NUBUCK
AND SUEDE.

Marmi
Marble

Cat. A

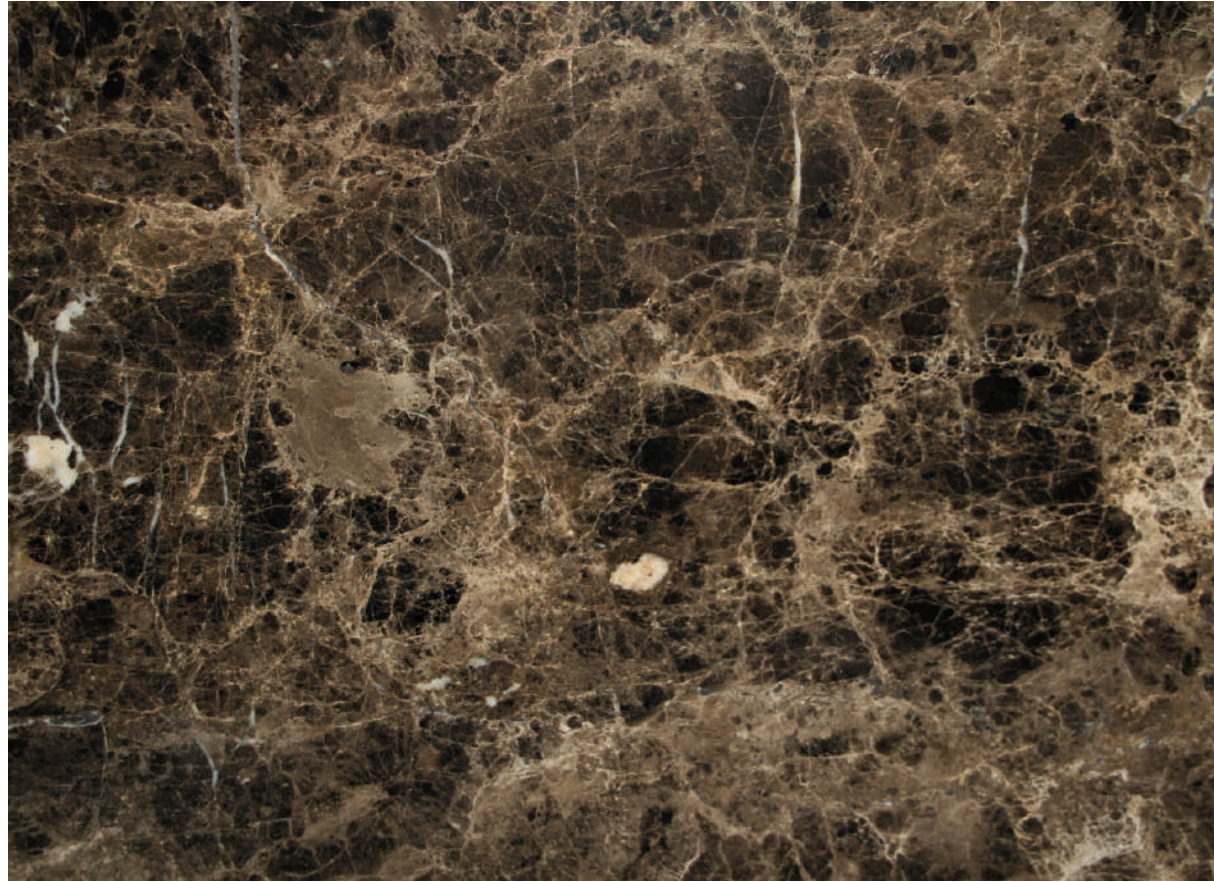

EMPERADOR

Marmi
Marble

Cat. B



RAIN FOREST BROWN

Cat. B

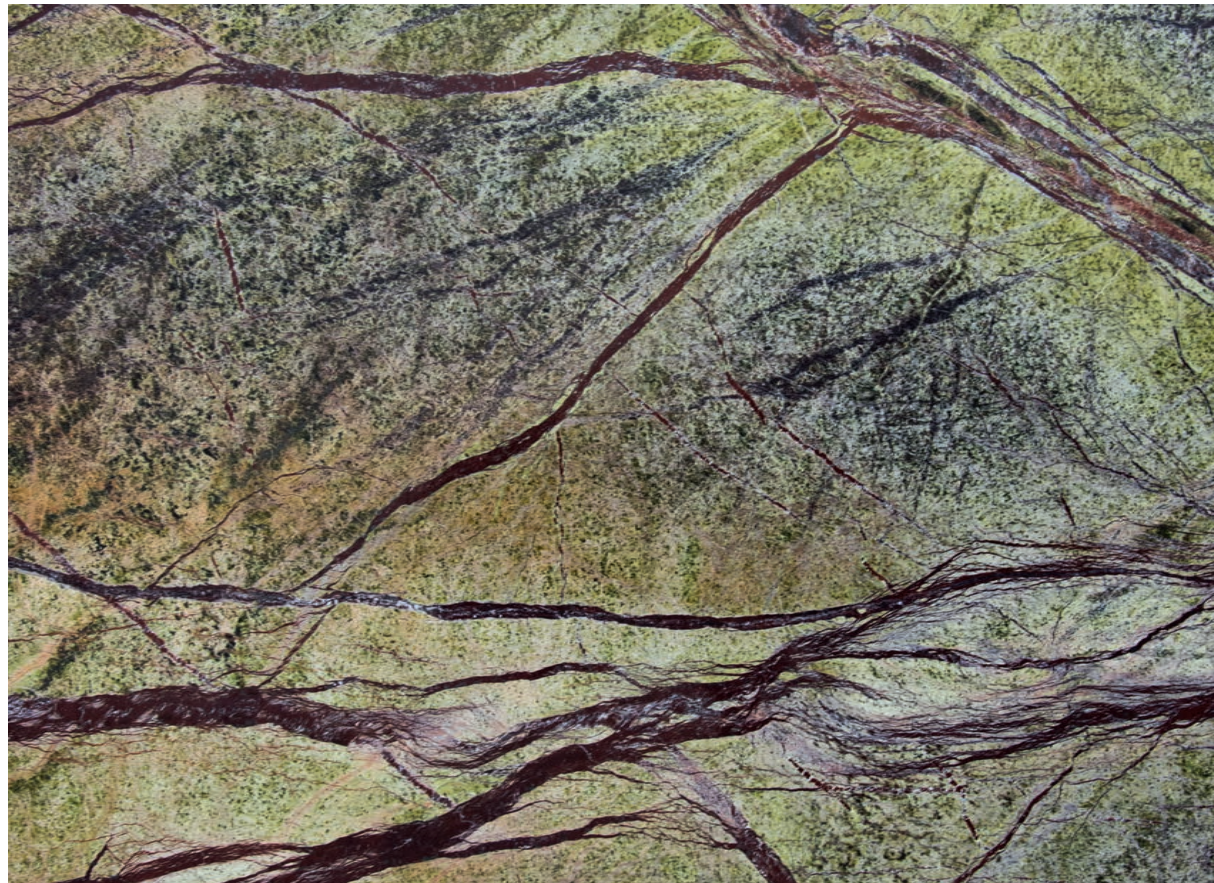

RAIN FOREST GREEN

Cat. C



AGATHA BLACK

Marmi
Marble

Cat. C

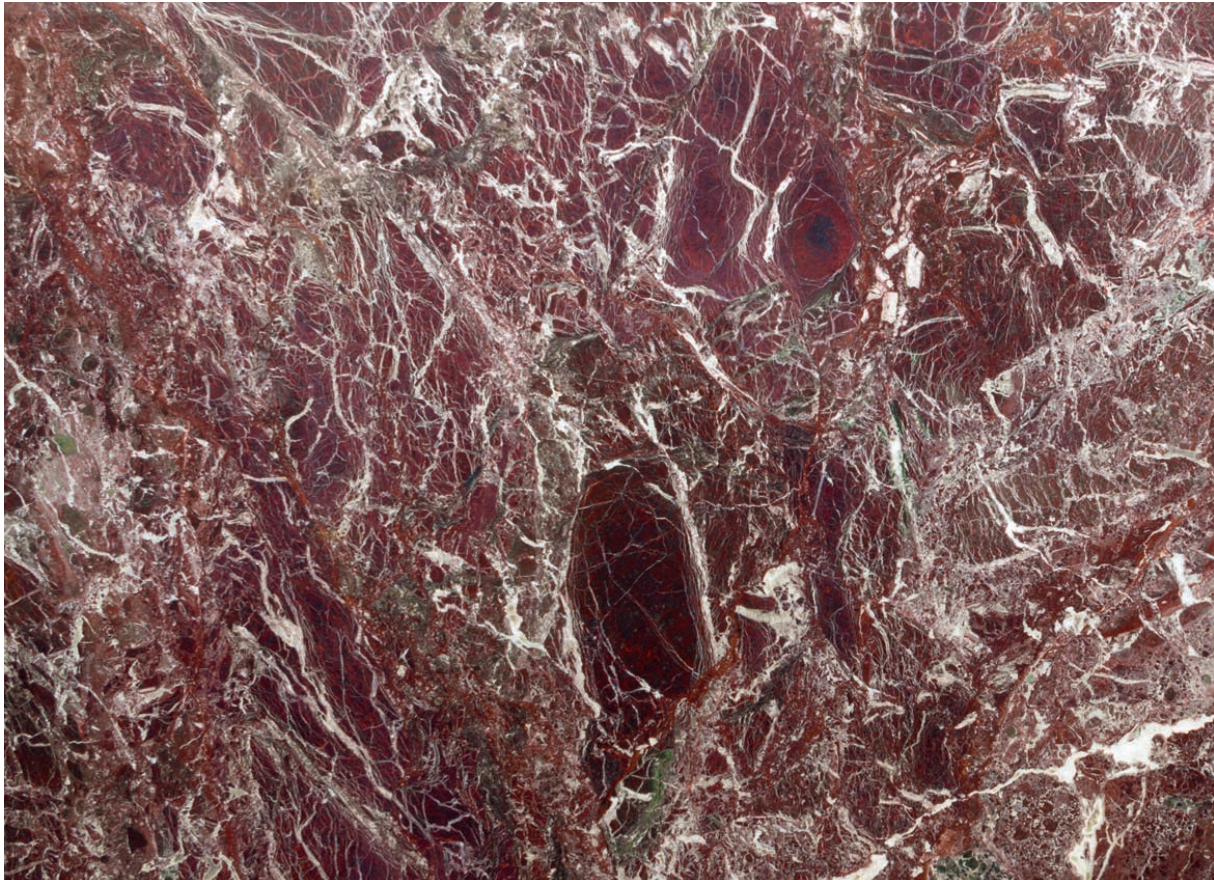

ROSSO LEVANTO

Cat. C



FIORI DI BOSCO

Marmi
Marble

Cat. C



SILVER ROOTS

Cat. C



ROSA ANTICO

Marmi
Marble

Cat. D



DOVER WHITE

Marmi
Marble

Cat. D

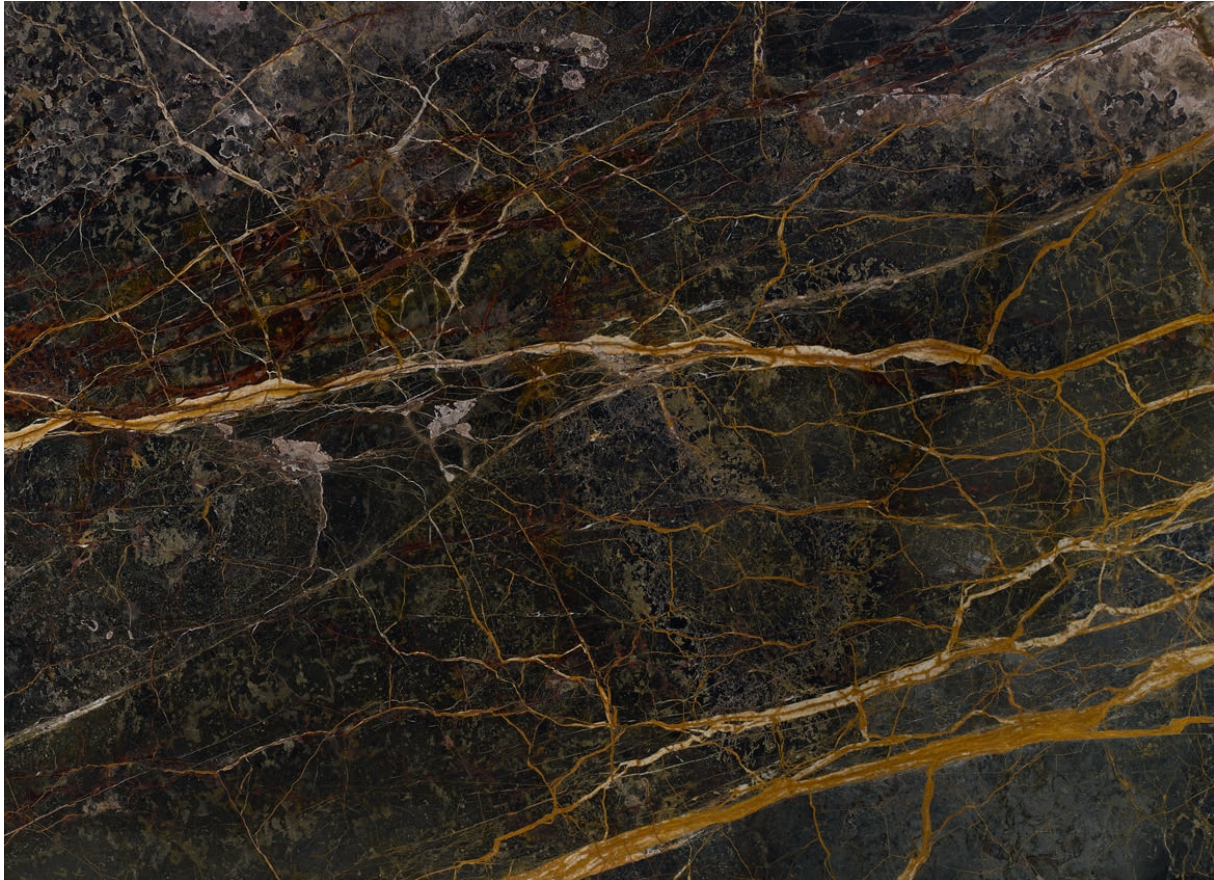

PORT SAINT LAURENT

Cat. D

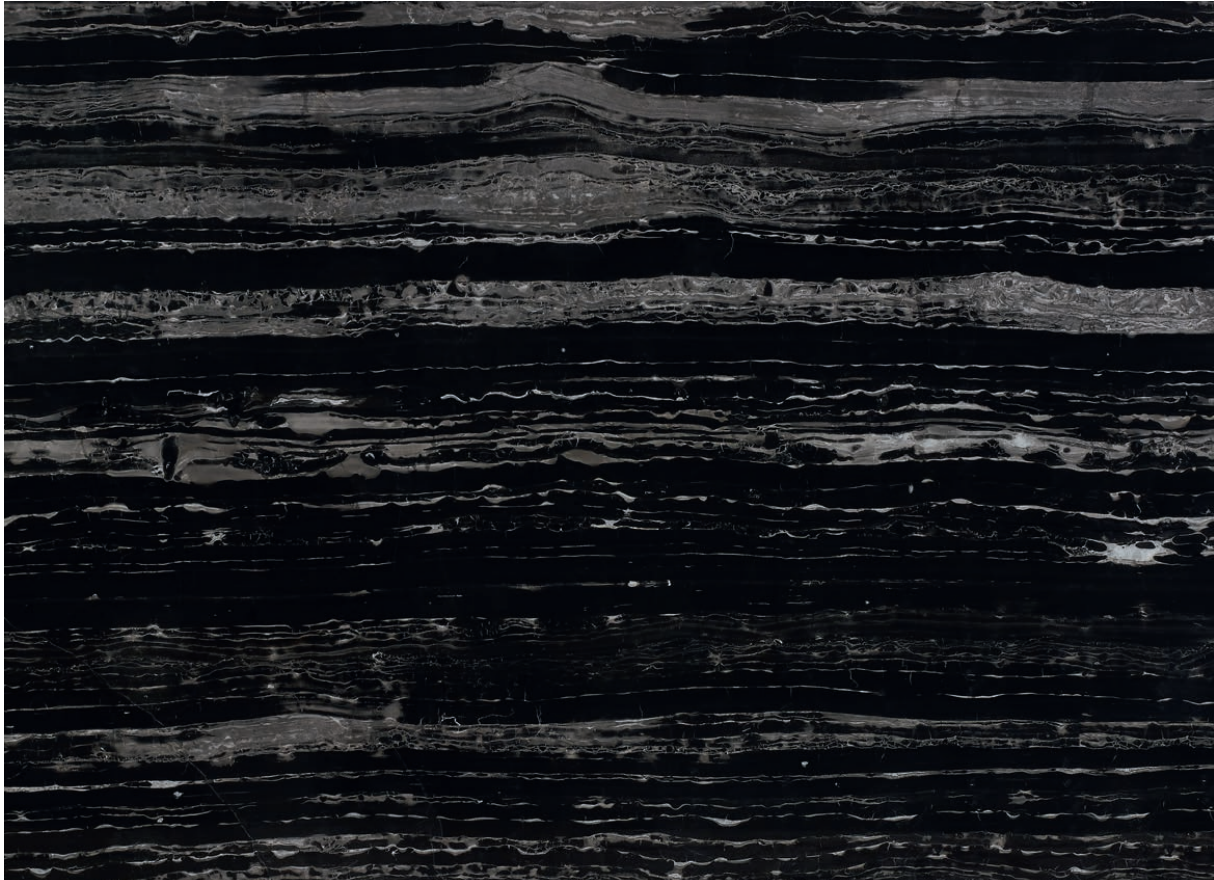

PORT BLACK

Cat. E



ILLUSION

Marmi
Marble

Cat. E



SPIDERMAN

Marmi
Marble

Cat. E

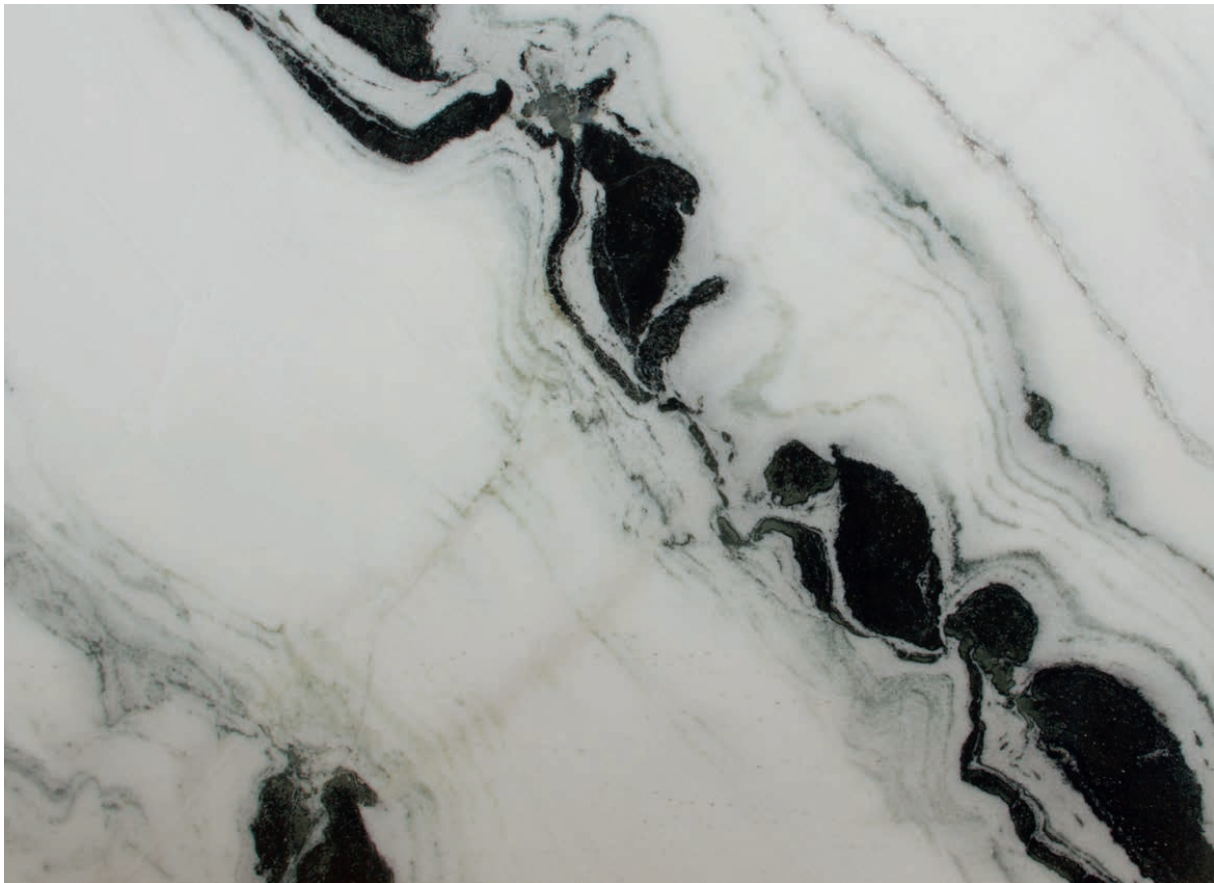

PANDA WHITE

Cat. E

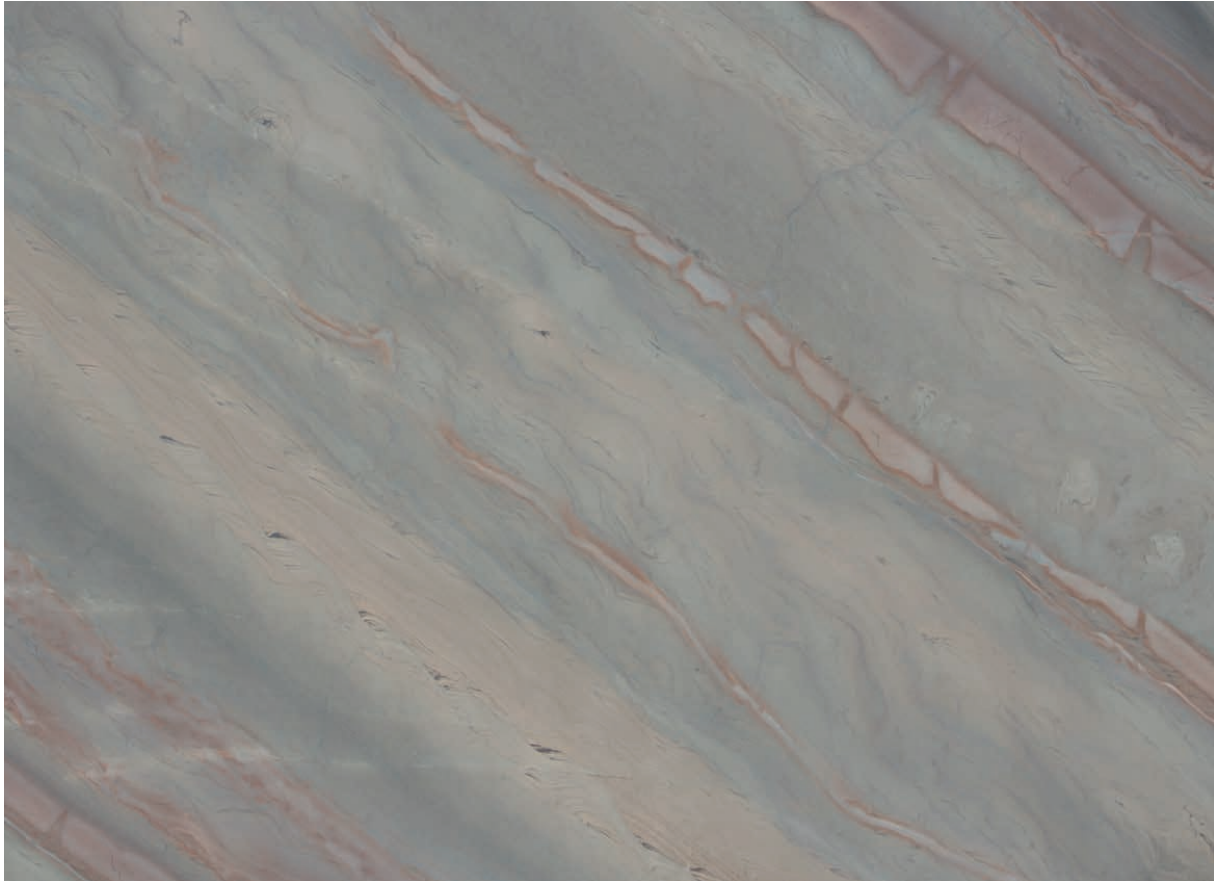

ELEGANT BROWN

Cat. F



CALACATTA ORO

Art Direction
DAINELLISTUDIO

Photography
STUDIO LEON

Print
TAP GRAFICHE

© SIGNORINI&COCO
LUGLIO 2020



DAYTONA

Daytona | Luxury brand by Signorini&Coco

Signorini-Coco&C. Srl
Via Lazio 41 56035
Perignano (Pisa) IT
T. +39 0587 616198
F. +39 0587 617540
info@signorinicoco.com
www.daytonahome.it

SHOWROOM MILANO
Via Alberico Albricci 9
20122 Milano IT
www.daytonahome.it

Signorini & Coco si riserva di apportare, senza preavviso, modifiche nei materiali, nei rivestimenti, nelle finiture e nei disegni dei prodotti presentati in questo catalogo. I colori dei materiali e delle finiture hanno un valore indicativo in quanto soggetti alle tolleranze dei processi di stampa.

Signorini & Coco reserves the right to make modifications to the materials, coatings, finishes and designs of the products presented in this catalogue without prior warning. The colours of the materials and finishes are purely an indication as they may differ slightly due to the printing processes.

