



Twils[®]

"look at me"

Twils[®]

"look at me"



Contents.

<i>Attico h.14</i>	~ 9	<i>Giselle h. 28</i>	~ 129
<i>Attico h. 28</i>	~ 15	<i>Giselle con gonna</i>	~ 133
<i>Calvin h. 25</i>	~ 25	<i>Dorian h.28</i>	~ 141
<i>Calvin h.15</i>	~ 31	<i>Camille Basso h.28</i>	~ 149
<i>Philip Basso h. 28</i>	~ 41	<i>Camille Alto Capitoné h. 28</i>	~ 155
<i>Philip Basso con gonna</i>	~ 43	<i>Soul h. 28</i>	~ 163
<i>Edo</i>	~ 49	<i>Boiserie Set Slim e Ada Sommier 3Lati h. 14</i>	~ 171
<i>Ekeko Plus h.28 Box</i>	~ 59	<i>Boiserie Set Slim e Ada Sommier 3Lati h. 14</i>	~ 177
<i>Ekeko Sommier h.28 Box</i>	~ 65	<i>Frick Basso h. 25</i>	~ 183
<i>Camaleo con Testiera e Pediera</i>	~ 75	<i>Frick Round h. 25</i>	~ 187
<i>Ada h. 14</i>	~ 83	<i>Medea h. 28</i>	~ 195
<i>Ada h. 28</i>	~ 89	<i>Furnishing accessories</i>	~ 201
<i>Ada Sommier h. 28</i>	~ 95	<i>Technical section</i>	~ 214
<i>Blanca h.28</i>	~ 103		
<i>Dread h. 14</i>	~ 111		
<i>Dread h. 25</i>	~ 113		
<i>Thomas Barrè h. 28</i>	~ 121		



Twils®

*E anche se è tutto un sogno, che importa.
Mi piace e voglio continuare a sognare.*

*And if it's all a dream, what does it matter.
I like it and I want to keep on dreaming.*

Archi, nicchie, portali, paraventi e tendaggi
delineano scenari metafisici e allusivi.
Ogni letto della nuova collezione Twils
rappresenta il punto focale di questi ambienti
ampi e luminosi, il protagonista della trama,
l'elemento che rivela la nostra inclinazione
allo stile e all'eccellenza.
È un punto d'arrivo, una promessa mantenuta.
È il nostro modo di amare la vita
e affermarne il valore.
#dreamingbetter

*Arches, recesses, doorways, screens and curtains
reveal metaphysical and allusive settings.
Each of the beds in the new Twils collection
is the focal point of these large, bright
and airy rooms, the protagonist of the story,
the element that reveals our propensity
for style and excellence.
It is the end of a journey, a promise kept.
It is our way of loving life
and asserting its value.
#dreamingbetter*

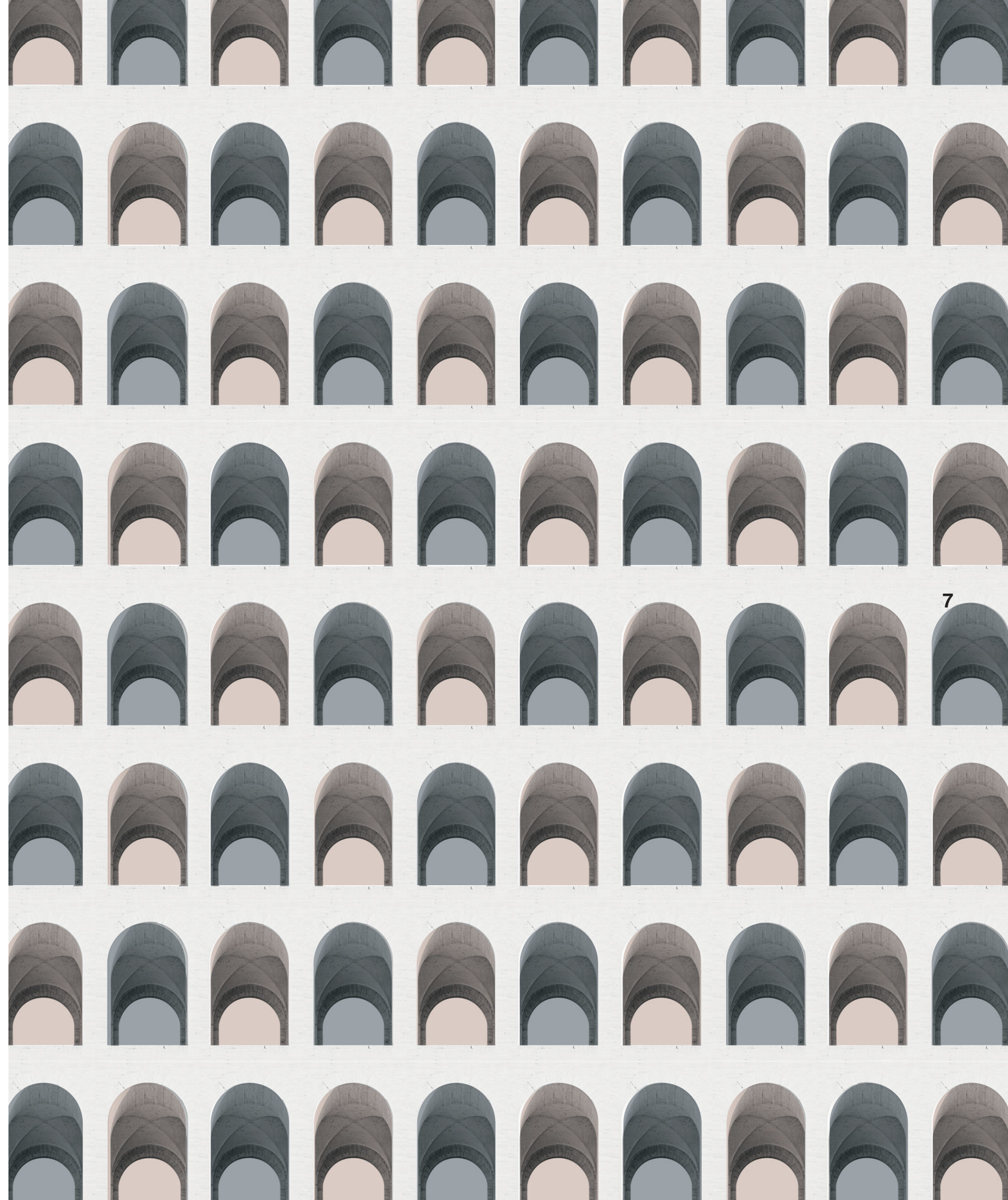



ATTICO

Design:
R&D Twils



Name of bed:
Attico h. 14
~
Design:
R&D Twils

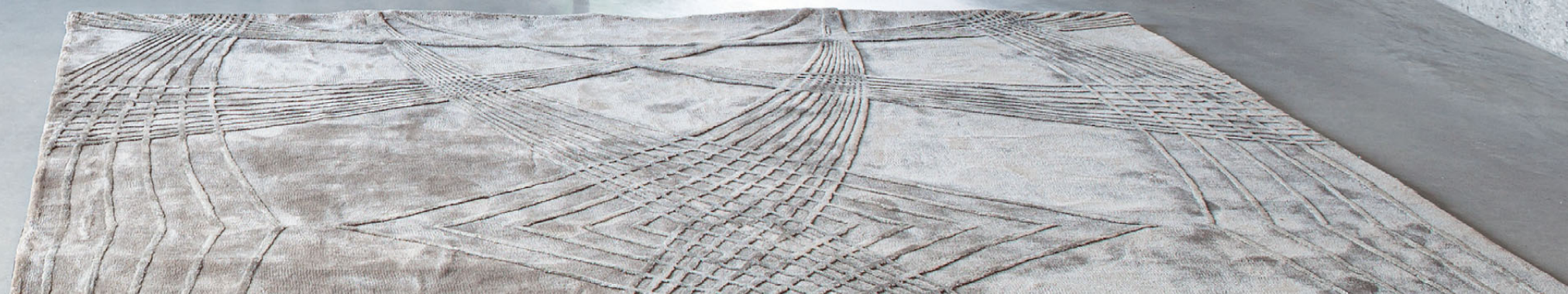



La morbida inclinazione della testiera caratterizza l'elegante silhouette di Attico. L'altra nota distintiva è rappresentata dai due confortevoli cuscini d'appoggio, che possono essere rivestiti con lo stesso tessuto della struttura o con uno a contrasto.

The gentle slope of the headboard accentuates the elegant silhouette of Attico. The other distinctive feature are the two comfortable cushions which can be upholstered in the same fabric as the structure or in a contrasting material.



LIFE IS ABOUT CREATING YOURSELF

EVERYDAY

*Arredare è un'attività creativa,
intima e profonda. È uno dei modi
più stimolanti per esprimere la nostra
personalità, marcare la nostra
differenza, dichiarare il nostro stile.
È un'affermazione del carattere.*

*Furnishing is a creative, personal
and deeply intimate activity. It is one
of the most stimulating ways of
expressing our personality, stressing
our difference, stating our style.
It defines our character.*

14



Name:
Poltrona Carnaby
Carnaby armchair
~
Design:
R&D Twils

15

Name of bed:
Attico h.28
~
Design:
R&D Twils



16

*The best and most beautiful things in the world cannot be seen
or even touched. They must be felt with the heart.*
Helen Keller

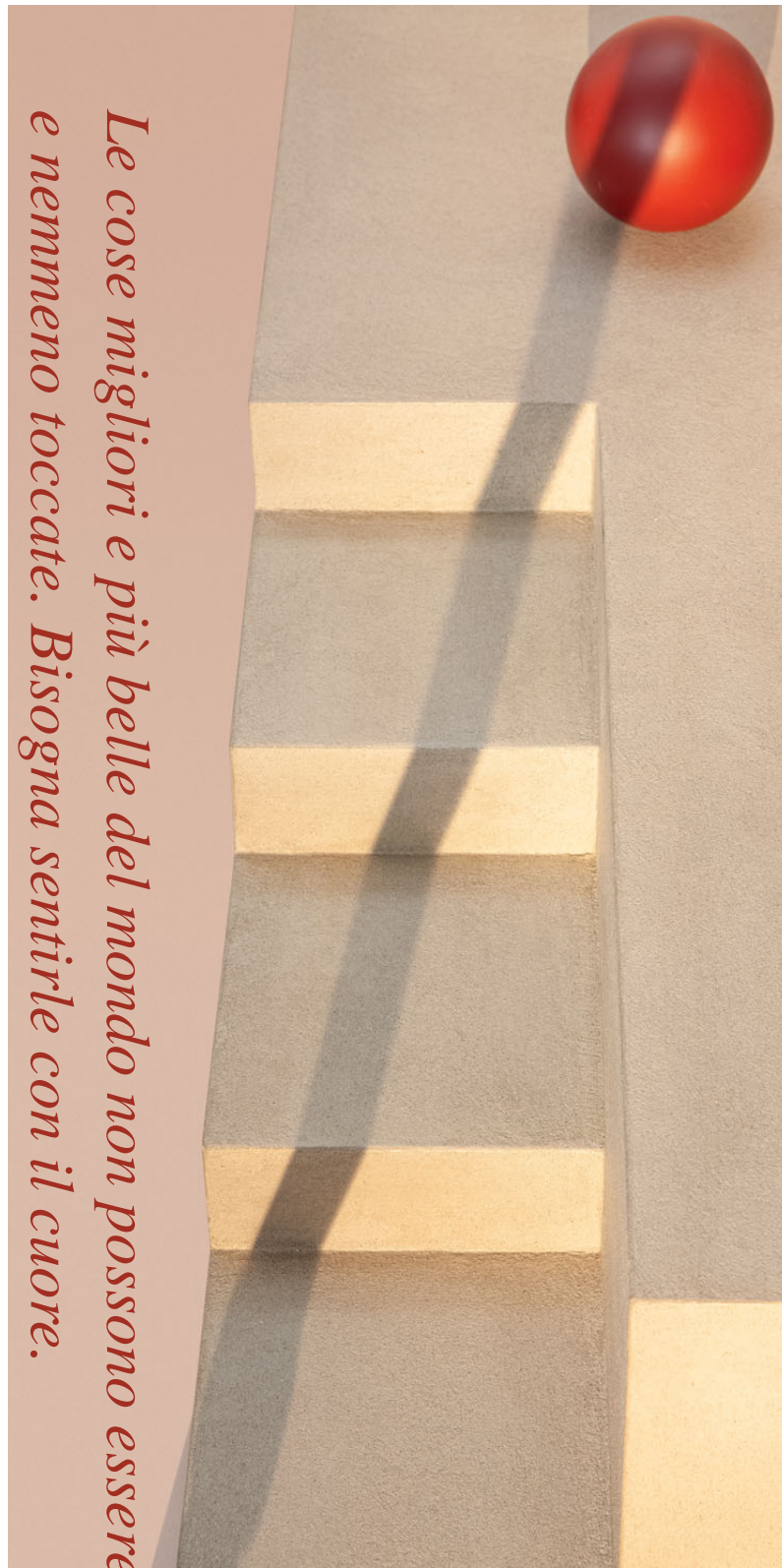

*Le cose migliori e più belle del mondo non possono essere viste
e nemmeno toccate. Bisogna sentirle con il cuore.*



17

Name of bed:
Attico h.28
~
Design:
R&D Twils

Un delicato equilibrio di linee e di volumi,
un esercizio di stile dedicato ai sognatori.
Il dettaglio dei due cuscini che rendono
confortevole lo schienale è una piccola
concessione ai piaceri della lettura,
del dialogo sommesso, della meditazione.
La vita è fatta anche di intimi momenti d'ozio,
che precedono e favoriscono il sonno.

*A subtle balance of lines and volumes,
an exercise in style for dreamers.
Two cushions have been placed on the
backrest for maximum comfort, a
small concession to the pleasure of
reading, quiet conversation and meditation.
These private moments of relaxation lull us
gently to sleep and are all part and parcel of life.*



**BE HAPPY FOR THIS MOMENT.
THIS MOMENT IS YOUR LIFE.**
BELIEVE ME



Name:
Pouf Condé
Condé footstool
~
Design:
Silvia Prevedello



22

Twils®

Il design, la moda e la creatività sono espressioni del pensiero. Chiedono passione, studio e applicazione, lasciando ampio margine alla libertà: si può scegliere di aderire o discostarsi, di sorprendere o conformarsi. L'importante è rimanere sempre fedeli a sé stessi.

Design, fashion and creativity are all ways of expressing our thoughts. They demand passion, study and dedication but leave plenty of room for freedom: you can choose to swim with or against the tide, surprise or conform. The important thing is to always be true to yourself.

23



24

CALVIN

Design:
Enrico Girotti

La testiera di Calvin si estende verso l'esterno come una grande corolla. Una forma sinuosa e avvolgente che abbraccia lo spazio, orienta e riflette la luce, esprime eleganza e comfort.

The headboard on Calvin stretches outwards like a flower opening in the sun. This rounded, protective shape embraces the space, directs and reflects the light and conveys elegance and comfort.



25

Name of bed:
Calvin h. 25
~
Design:
Enrico Girotti

26



27



28



Calvin è incline al free standing, perché è accuratamente rifinito in ogni sua parte visibile e attraente da qualunque angolazione, prezioso nei dettagli e nobile nel profilo.

Calvin is ideal for free standing because every visible part is flawlessly finished and it looks great from any angle. Its details are exquisite and its profile sophisticated.

29





*I colori, come i lineamenti,
seguono i cambiamenti delle emozioni.
Colors, like features,
follow the changes of the emotions..*

Pablo Picasso

Secondo alcune filosofie orientali, il pesce rosso è un simbolo di rinascita e rinnovamento. Compare in queste pagine come ospite inatteso e benvenuto, a rappresentare la nostra propensione per il cambiamento, l'evoluzione, il miglioramento.

In some oriental philosophies, the goldfish is a symbol of rebirth and renewal. It appears on these pages as an unexpected but welcome guest, testimony of our inclination for change, evolution and enhancement.



Name of bed:
Calvin h. 15
~
Design:
Enrico Girotti





Calvin cambia aspetto a seconda del rivestimento scelto, dell'altezza del giroletto e degli accessori che lo decorano. La morbida svasatura dei piedini è un dettaglio che aggiunge grazia e armonia. Un letto che si fa ammirare in ogni contesto di stile.

Calvin changes its appearance depending on the upholstery, the height of the bedstead and the accessories chosen to embellish it. The gently tapered feet add an element of grace and harmony. It is a bed that never fails to attract admiring glances, whatever the style setting.

36



37





38

Name:
Divano Lucas l. 170
Lucas l. 170 sofà
~
Design:
R&D Twils

Twils collections feature a wide variety of accessories to meet all functional needs, like the stylish Lucas sofa. They also include armchairs, footstools, chairs, coffee tables and ranges of modular elements that can be combined to create containers, bookcases and practical surfaces to put things on.

Le collezioni Twils comprendono tanti complementi per ogni esigenza funzionale, come l'elegante divanetto Lucas. La gamma comprende anche poltroncine, pouf, sedie, tavolini e programmi modulari per componere contenitori, librerie e piani d'appoggio.



39

40



41



PHILIP BASSO

Design:
R&D Twils

La linea contemporanea e impeccabile di Philip è caratterizzata dalla testiera, concepita in modo da apparire come suddivisa in due soffici cuscini d'appoggio. Con l'aggiunta del rivestimento a gonna acquisisce un inatteso tono romantico.

The contemporary and impeccable design of Philip is accentuated by the headboard, which appears to be divided into two soft cushions. The valance gives the bed an unexpected romantic feel.

Name of bed:
Philip Basso h.28
~
Design:
R&D Twils

42



43





**REMEMBER, TODAY IS THE TOMORROW
YOU WORRIED ABOUT YESTERDAY.**





*Il colore!
Che linguaggio profondo e misterioso,
il linguaggio dei sogni.*

*Color!
What a deep and mysterious language,
the language of dreams.*

Paul Gauguin

La casa è il luogo dove si svolge la nostra vita quotidiana e dove avvengono cose straordinarie. La conosciamo talmente bene da poterci orientare anche al buio, e quando rientriamo siamo sorridenti perché finalmente ci sentiamo protetti. È calore, ordine, intimità.

Most of our daily lives is spent in our home, it's the place where the extraordinary happens. We know it so well we can find our way around in the dark, and when we cross the threshold, we can't help but smile because we are finally safe. Our home is warmth, order, intimacy.



Name:
Panchetta Coffe 45x135
Coffer bench 45x135
~
Design:
R&D Twils

Edo è ideale per chi desidera un letto classico e attuale allo stesso tempo, adatto all'inserimento in ogni contesto di stile. Accuratamente rifinito in ogni sua parte, soffice, invitante e praticissimo da sfoderare, è l'essenza del letto tessile.

Edo is ideal if you're looking for a classic yet contemporary bed that looks at home with any décor. Every part is flawlessly finished, it is soft, inviting, with easy-to-remove covers: the upholstered bed par excellence.

EDO

Design:
R&D Twils



48

EVERY MOMENT
IS A FRESH BEGINNING.
CHANGE



49



ELEGANCE IS THE ONLY BEAUTY THAT NEVER FADES.

Edo crea un'invitante oasi di relax,
una soffice promessa di comfort.
Il tessuto scelto per il rivestimento
condiziona e modifica la percezione
dei suoi volumi generosi. In versione
total white esprime luce e purezza.

Edo lures us into a haven of relaxation
with its soft promise of comfort.
The fabric chosen for the upholstery
conditions and changes our
perception of its generous volumes.
The total white version conveys light and purity.

Name of bed:
Edo
~
Design:
R&D Twils





52

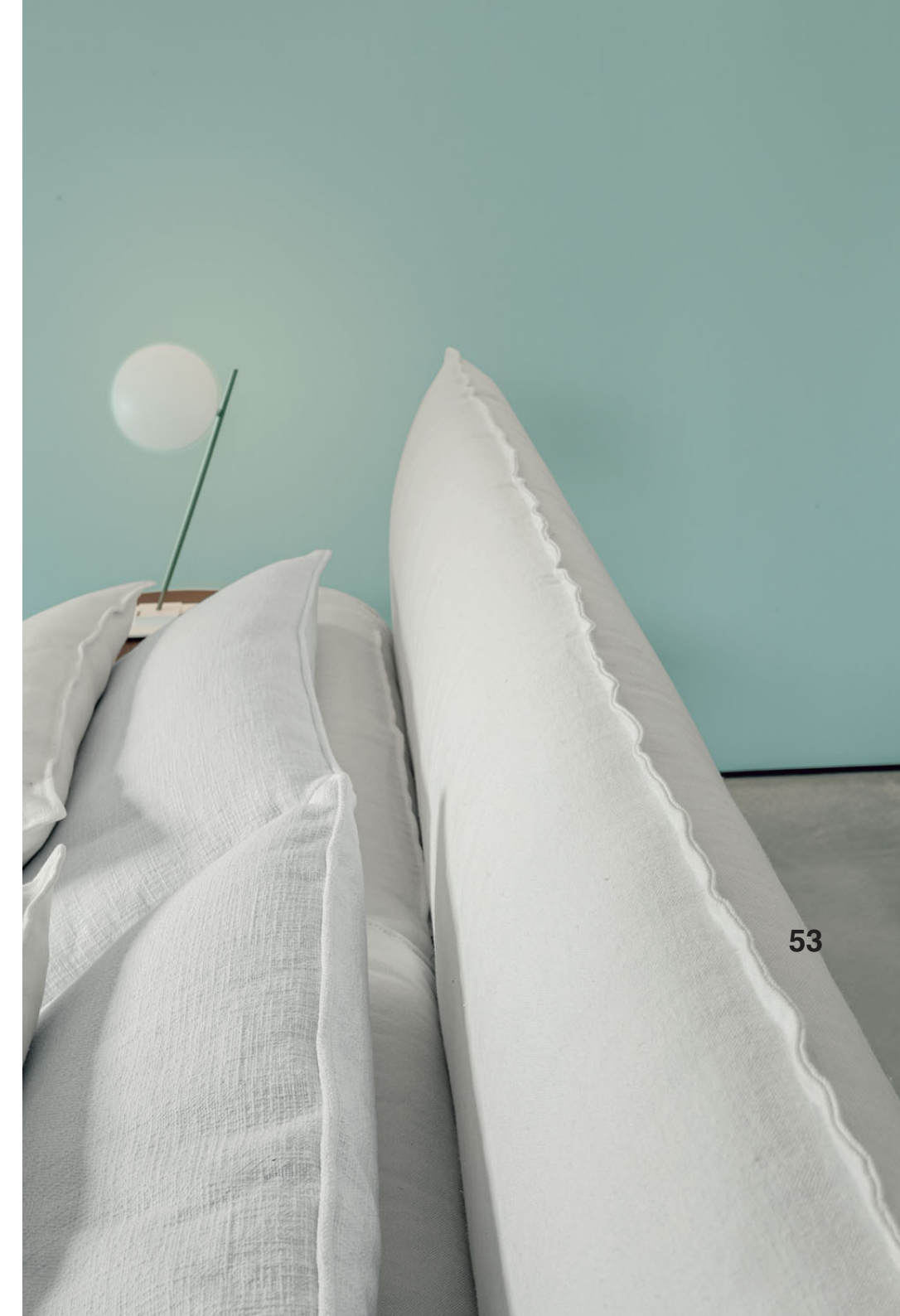
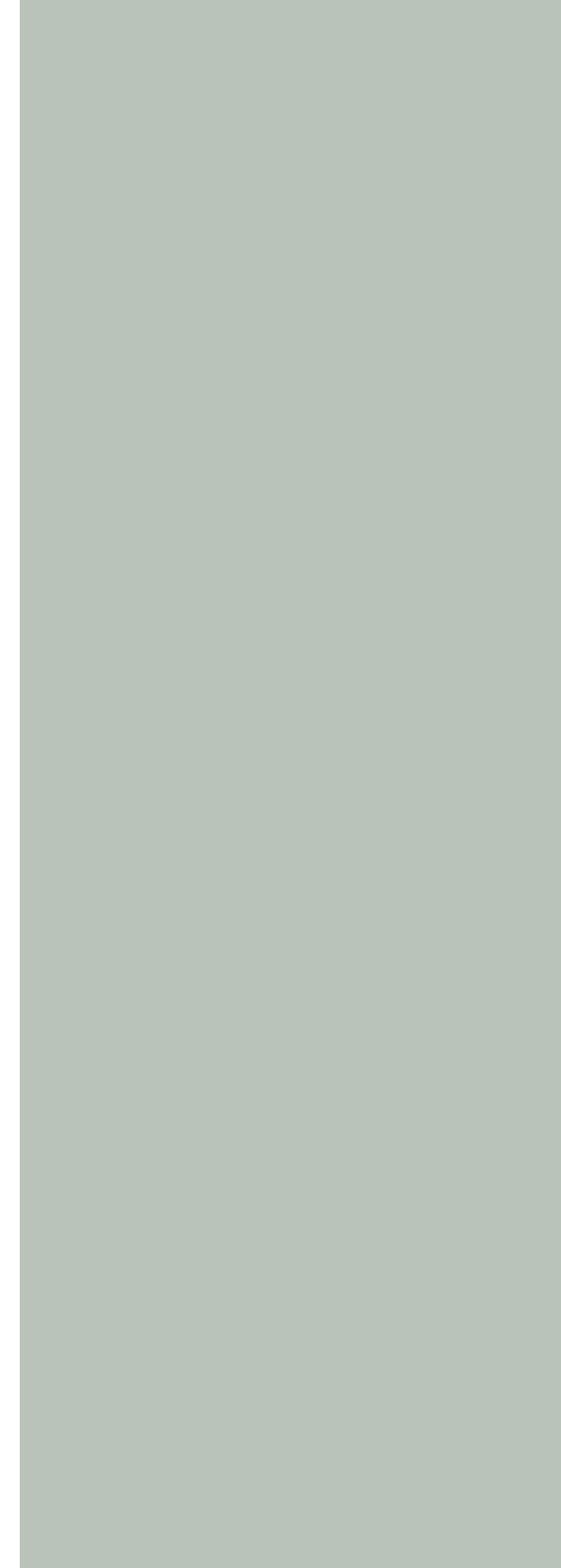

53

Edo rivela un inaspettato coté romantico, sottolineato dalla purezza della biancheria e dei complementi tessili: lo stile è fatto anche di dettagli e accostamenti preziosi.

Edo reveals an unexpected romantic side that comes through even more with plain, simple bed linen and textile accessories: style is also in the details and clever combinations.

Name:
Panchetta Adam 60x120
Adam bench 60x120
~
Design:
R&D Twils



54

La forma, il colore, i materiali, le texture:
sono tanti i fattori e gli ingredienti
che entrano in gioco nella progettazione
degli elementi d'arredo. Ogni nuova idea
è un'opportunità, che si traduce in qualcosa
di bello, utile, desiderabile e unico.

*Shape, colour, materials, textures:
many different elements and ingredients
are involved when designing furniture. Every
new idea is an opportunity that is transformed
into something beautiful, useful, desirable
and unique.*



55



**CREATIVITY
IS INTELLIGENCE
HAVING FUN.**

*Vivere è cambiare, è questa la lezione
che ci insegnano le stagioni.*

*To live is to change, this is the lesson
the seasons teach us.*

Paulo Coelho

Amiamo il cambiamento, la trasformazione,
il rinnovamento dei colori, delle trame
e delle fantasie che rendono attraenti
e sempre attuali i nostri prodotti. Osserviamo
e talvolta anticipiamo le tendenze,
in un appassionante gioco fatto di ricerca,
applicazione e confronto. Le nostre emozioni
cambiano, ma la magia e la bellezza
sono parte di noi.

*We love change, transformation,
exciting new colours, textures and
patterns that make our products
eye-catching and contemporary.
We follow and, at times, anticipate
trends, as we passionately research,
apply and compare. Our emotions may
change but magic and beauty are
part of us.*

EKEKO PLUS

Design:
Cairolì & Donzelli



59

*Migliorare è cambiare;
essere perfetti è cambiare spesso.*

*To improve is to change;
to be perfect is to change often.*

Winston S. Churchill



58

Name of bed:
Ekeko Plus h. 28 Box
~
Design:
Cairoli & Donzelli

60



61

Name of bed:
Ekeko Plus h. 28 Box
~
Design:
Cairolì & Donzelli



Ekeko è caratterizzato dall'avvolgente testiera, resa confortevole da due morbidi cuscini, e dalla particolare forma del giroletto che ricorda la chiglia di un'imbarcazione. Un fattore caratterizzante inconfondibile.

Ekeko makes a statement with its rounded headboard, whose comfort is guaranteed by two soft cushions, and the unusual shape of the bedstead that is reminiscent of the keel of a boat. An unmistakable standout detail.





Name:
Pouf Clove e Pouf Rotondo
Clove footstool and Round footstool
 ~
 Design:
Silvia Prevedello - R&D Twils

Name:
Pouf Albert
Albert footstool
 ~
 Design:
R&D Twils



Name of bed:
Ekeko Sommier h. 28 Box
~
Design:
Cairolì & Donzelli

66



67





68

Nella versione sommier, Ekeko è ideale per il posizionamento a centro stanza. Un'isola di stile e comfort, che possiamo impreziosire giocando creativamente coi tessuti e coi colori, personalizzandolo.

The sommier version of Ekeko looks perfect when placed in the middle of the room. It is a stylish, comfortable island we can dress up by getting creative with fabrics and colours, adding our own personal stamp.



69

**La parola chiave è cambiamento.
Di prospettiva e di orizzonte, alla ricerca
di nuove esperienze e di punti di vista
non convenzionali. Per avere più energia,
entusiasmo e vitalità. Per migliorare.**

**The key word here is change. Change
of perspective and horizon, in search
of new experiences and unconventional
points of view. To give us more energy,
enthusiasm and vitality. To improve.**

70



Come tutti i letti Twils, anche Ekeko è accessorato con un capiente box contenitore dal meccanismo resistente e sicuro, di facile manutenzione e pulizia, realizzato assecondando la particolare curvatura della scocca. Un riuscito connubio tra estetica e funzionalità.

Like all Twils beds, Ekeko is fitted with a large storage container with a safe and sturdy opening mechanism. It is easy to maintain and clean and exploits the curved shape of the frame. A successful combination of aesthetics and functionality.

71





72

**TRUE LIFE
IS LIVED WHEN
TINY CHANGES
OCCUR**

Name:
Divano Lucas l. 130
Lucas sofà l. 130
~
Design:
R&D Twils



73



CAMALEO

Design:
Studio Thesia Progetti



Giovane, stiloso e contemporaneo. Grazie alle innumerevoli possibilità di configurazione offerte dagli elementi e dagli accessori tessili del programma, Camaleo è il letto che componete voi assecondando la vostra personalissima idea di stile. Da un'idea razionale nasce il letto ideale.

Young, stylish and contemporary. Thanks to the endless configuration options afforded by the different elements and textile accessories in the range, you can create a Camaleo bed that matches your own very personal idea of style. Take a rational idea and turn it into your ideal bed.

Name of bed:
Camaleone con Testiera e Pediera
~
Design:
Studio Thesia Progetti

76



77



Scelto il colore della struttura, la personalizzazione continua con gli accessori, i rivestimenti, i cuscini e la biancheria, fino al risultato finale: coloratissimo o monocromo, rigoroso o morbido, comunque funzionale e intrigante. Camaleo: start the creative game.

After you've chosen the colour of the structure, you can further personalise your bed with accessories, upholstery, cushions and linen until you have the end product: brightly coloured or monochrome, crisp or soft lines, it will always be functional and interesting. Camaleo: start the creative game.

THERE IS NOTHING PERMANENT EXCEPT CHANGE

Nella vita e nel design, siamo perennemente alla ricerca di nuove prospettive e di esperienze inedite. Per avere più energia, immaginazione e vitalità. Per migliorare, per stimolare la creatività e le idee, per crescere, per concepire prodotti esclusivi.

In life and design, we are constantly in search of fresh perspectives and new experiences. To infuse us with renewed energy, imagination and vitality. To improve, to stimulate our creativity and ideas, to grow, to dream up exclusive products.



Name:
Poltrona Lucas l. 75
Lucas armchair l. 75
~
Design:
R&D Twils

ADA

Design:
R&D Twils

83



L'armonia delle proporzioni e l'eleganza dei contorni rendono Ada attraente e unico: lo sguardo si sofferma sui dettagli distintivi come l'orlo ribattuto sui profili della testiera e del giroletto. Design contemporaneo, tanto creativo quanto razionale.

The harmonious proportions and elegant lines make Ada eye-catching and unique: our eyes are drawn to its distinctive details, like the flat-felled seams on the headboard and bedstead surround. A creative but equally rational contemporary design.

COLOR IS A MATTER OF TASTE AND SENSITIVITY



82

Name of bed:
Ada h.14
~
Design:
R&D Twils

84



85





L'agile giroletto h.14 rende Ada un letto giovane nella forma e nello spirito. L'alta testiera, suddivisa in due parti, ha un aspetto morbido e invitante. La cifra estetica è sottolineata dagli agili piedini.

The slim bedstead h.14 gives Ada a youthful shape and verve. The high headboard, divided into two, is soft and inviting. Its aesthetic is further defined by the slender feet.

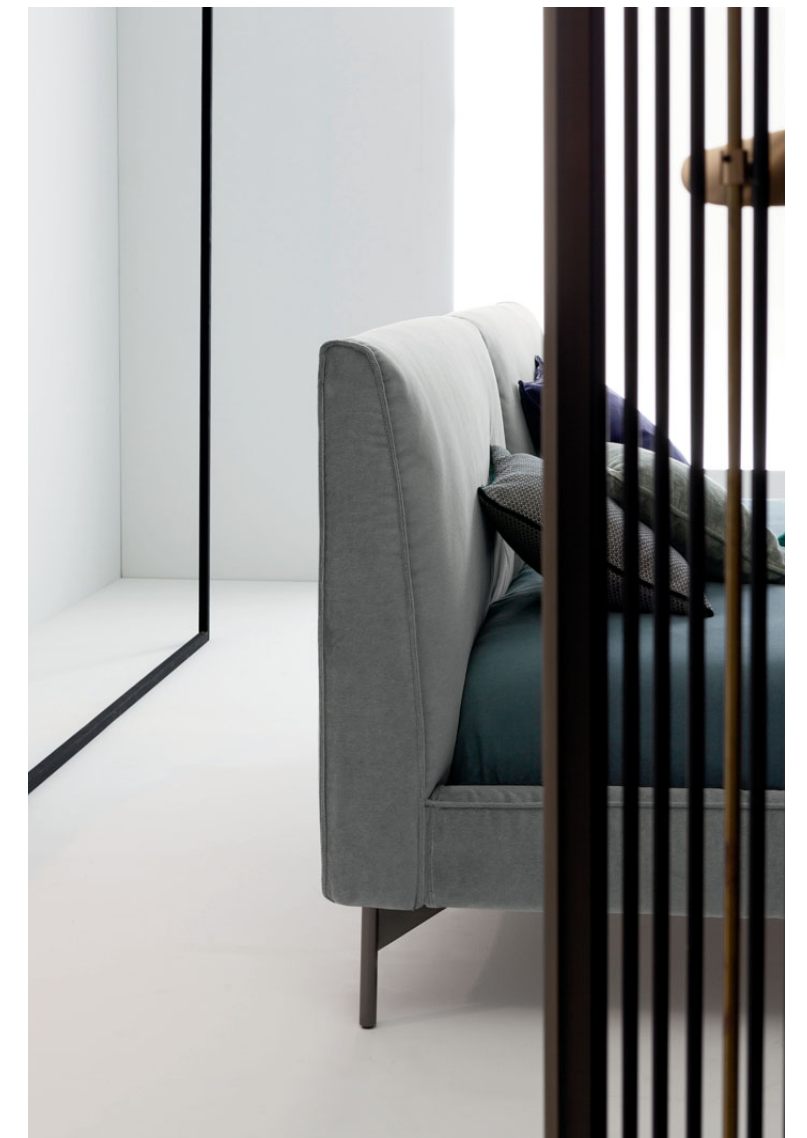



Name:
Poltrona Desert
Desert armchair
 ~
 Design:
Antonio Fattore

La casa è il teatro dei nostri gesti quotidiani,
 lo specchio della nostra personalità, lo spazio
 dove esprimiamo liberamente la nostra creatività.
 Ogni casa è unica, perché ospita i nostri affetti,
 i nostri ricordi e conosce i nostri progetti per il futuro.
 Un letto Twils è destinato a diventarne il cuore.

*Our home is where we act out our daily lives,
 it reflects our personality, it is the place where
 we can freely express our creativity. Every home
 is unique because it is the vessel of our affections
 and memories and knows our plans for the future.
 A Twils bed becomes the heart of any home.*

Name of bed:
Ada h. 28
~
Design:
R&D Twils

90



91



92

Il giroletto h. 28, idoneo a ospitare un capiente e pratico box contenitore, ridefinisce la percezione dei volumi di Ada. La suddivisione della morbida testiera in due parti simmetriche diventa un singolare elemento decorativo. Lo sguardo si sofferma sui dettagli distintivi, come l'orlo ribattuto che orna tutti i profili definendo le forme.

The bedstead h. 28, which houses a large handy storage container, redefines our perception of Ada's volumes, becoming a unique decorative feature. Our eyes take in the exclusive details, like the flat-felled seam along all the edges which defines the shapes.



93



I complementi Twils rendono la zona notte più bella, funzionale e confortevole. Mobili contenitore, pouf, poltroncine, panchette e divanetti completano l'arredo e arricchiscono ogni ambiente con un'esclusiva impronta di stile.

Twils accessories never fail to make the bedroom more beautiful, functional and comfortable. Containers, footstools, armchairs, benches and sofas add the finishing touch to the décor and make an exclusive style statement in any room.

Name:
Panchetta Oscar
Oscar bench

Design:
R&D Twils

IN ONE DROP OF WATER
ARE FOUND ALL THE SECRETS
OF ALL THE OCEANS



Name of bed:
Ada Sommier h. 28
~
Design:
R&D Twils

96

97





In versione sommier, il giroletto di pura e rigorosa geometria è impreziosito dal dettaglio sartoriale degli orli ribattuti che sottolineano il contorno. Il tessuto di rivestimento, la biancheria e gli accessori tessili personalizzano lo stile, trasformando Ada nella nostra privatissima oasi di comfort.

In the sommier version, the bedstead with its clean, minimal lines is enhanced by the bespoke flat-felled seams that define the edges. The upholstery, bed linen and textile accessories personalise the style, making Ada our own private haven of comfort.

COLORS FOLLOW THE CHANGES OF THE EMOTIONS

PABLO PICASSO





100

Name:
Tavolino Simplit
Simplit table
~
Design:
Bottino & Tinti

Si dice che sognare la casa significa confrontarsi con la propria personalità. Ogni oggetto ha un significato simbolico, ogni dettaglio rivela nuove opportunità, nuovi progetti da affrontare, il nostro perpetuo bisogno di cambiamento.

They say that planning your dream home is like revealing your personality. Every object has symbolic meaning, every detail reveals new opportunities, new projects to take on and our never-ending need for change.



Name:
Pouf Soft 90x90
Soft footstool 90x90
~
Design:
R&D Twils

101

BLANCA

Design:
R&D Twils



Due cuscini oversize rendono morbida e accogliente la testiera di Blanca, leggermente inclinata per favorire il comfort. Un letto essenziale, di impronta soft, ricco di personalità e spessore.

Two oversized cushions make the Blanca headboard, which slopes gently back for greater comfort, soft and welcoming. An essential yet soft-looking bed that is packed with personality and depth.



Name of bed:
Blanca h. 28
~
Design:
R&D Twils

104

105



106



Attingendo al ricchissimo campionario di tessuti e colori che contraddistingue il lifestyle Twils, ogni modello può essere configurato con grande libertà creativa.

By choosing from the extensive range of fabrics and colours in the Twils lifestyle collection, every bed can be configured with total creative freedom.

I cuscini della testiera possono essere rifiniti con un'elegante bordatura a contrasto di gusto sartoriale, che aggiunge carattere e stile alle forme comode, soffici e invitanti di Blanca.

The cushions on the headboard can be decorated with elegant contrasting piping, a bespoke detail that adds character and style to Blanca's comfortable, soft and inviting shapes.

107



Name:
Divano Lucas l. 130
Lucas sofà l. 130
~
Design:
R&D Twils

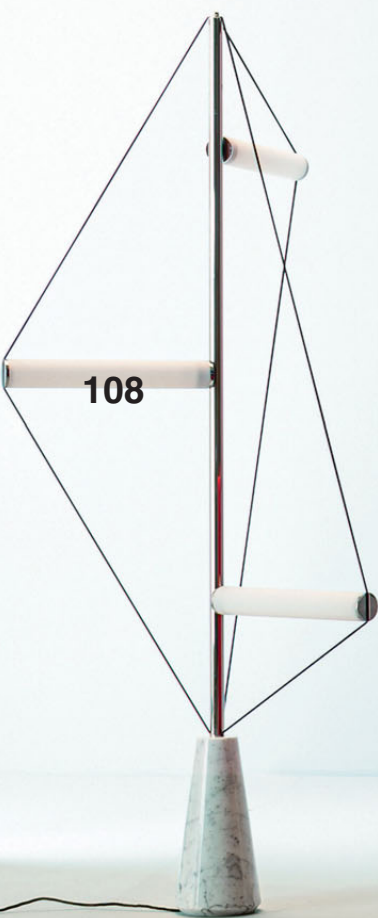

SILENCE ISN'T EMPTY, IT'S FULL OF ANSWERS.

La cultura tessile di Twils si esprime anche nell'ampia gamma di divanetti, poltrone e poltroncine, utili e classici complementi della zona notte. Con la loro impronta decorativa aggiungono stile, moltiplicano il comfort e rendono più funzionale ogni ambiente.

Twils also produces a wide range of sofas and large and small armchairs - practical, classic accessories for the bedroom. With their decorative details, they add style, heighten comfort and make every room more functional.



DREAD

Design:
R&D Twils

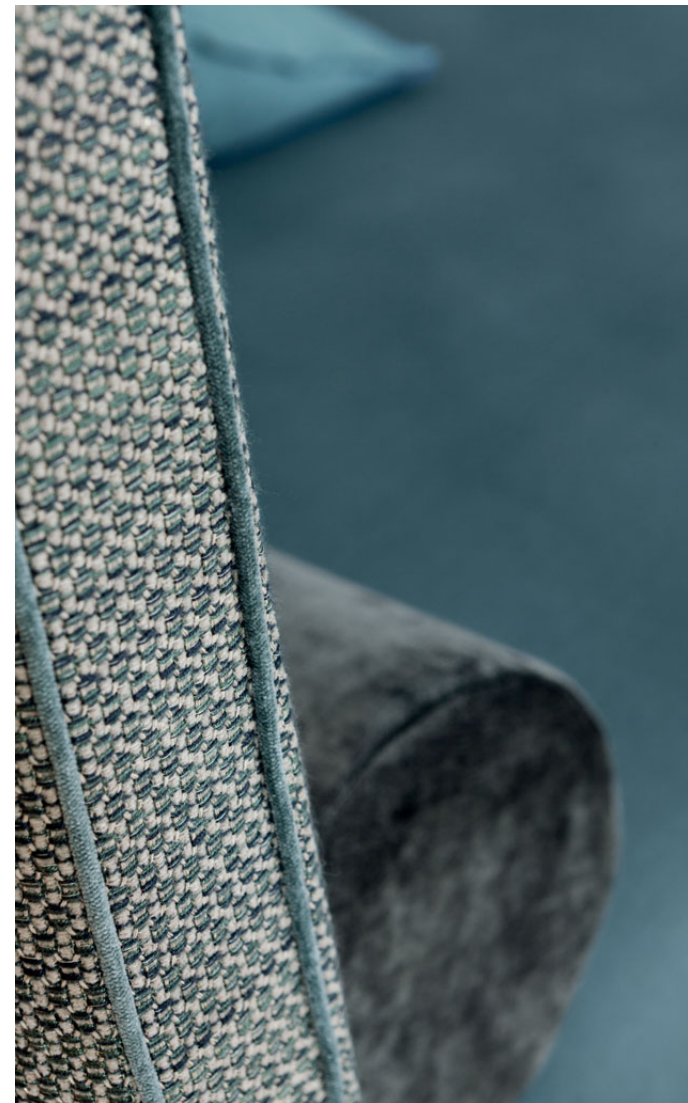

Il giroletto h.14 conferisce a Dread leggerezza e slancio, accentuati dai piedini sottili e delicatamente svasati. L'elegante bordatura che orna i profili della testiera è un dettaglio squisitamente sartoriale.

The bedstead h.14 gives Dread a feeling of lightness and energy which is accentuated by the slender, daintily tapered feet. The elegant piping around the headboard is an exclusive bespoke detail.

Name of bed:
Dread h. 14
~
Design:
R&D Twils

112

113



*Stile contemporaneo, linee rigorose,
gusto internazionale e smart design.
L'alta testiera è morbidamente imbottita
nella parte superiore, per un comfort unico
a fronte di un ingombro contenuto.*

*Contemporary style, minimal lines,
international appeal and smart design.
The high headboard is softly padded at
the top, offering unbeatable comfort
without taking up too much space.*

114



Name of bed:
Dread h. 25
~
Design:
R&D Twils

115





THE THINGS THAT WE LOVE TELL US WHAT WE ARE.

BE FREE

La cassettera può essere laccata lucida oppure opaca, in un'accattivante e vasta gamma di esclusive tonalità. La razionalità geometrica delle forme consente numerose combinazioni, accostamenti e funzionalità.

The chest of drawers can have a glossy or matt lacquered finish in an extensive, eye-catching range of exclusive colours. The geometric rationality of the shapes allows for numerous combinations, pairings and uses.



Name:
Settimanali Tetris
Tetris chest of drawers
~
Design:
Cairoli & Donzelli

THOMAS

Design:
R&D Twils

120



Thomas seduce per l'armonia delle proporzioni e per il profilo delicato ed espressivo della testiera morbidamente imbottita, tratteggiata da eleganti impunture verticali.

What makes Thomas so irresistible is the harmony of its proportions and the delicate, expressive profile of the headboard with its soft padding and elegant vertical stitching.

121



Name of bed:
Thomas Barrè h. 28
~
Design:
R&D Twils



122



123



Come molti modelli Twils, anche Thomas può essere posizionato a centro stanza, dove può essere ammirato da qualunque angolazione. Un letto sobrio, generoso, adulto.

Like a lot of the Twils models, Thomas can be positioned in the middle of the room where it can be admired from any angle. It is an understated, generous and adult bed.



Twils®

*Alcune persone cercano un posto bello.
Altri rendono un posto bello.*

*Some people look for a beautiful place.
Others make a place beautiful.*

Hazrat Inayat Khan

Lo stile cambia per definizione. È legato a epoche, luoghi, abitudini e schemi che spesso vanno messi in discussione, rinnovati, sovvertiti. È questo lo spirito di ricerca che anima ogni nuova collezione Twils: proporre nuove soluzioni estetiche e funzionali, cambiare pelle, aggiornarsi, elaborare gli stimoli imposti dall'evoluzione. E ogni volta sarà un nuovo inizio.

Style changes by definition. It is linked to different times, places, habits and conventions that are often questioned, endorsed or overturned. This is the spirit that drives the research of every new Twils collection: coming up with new aesthetic and functional solutions, changing our skin, moving with the times, developing the ideas imposed by evolution. And every time it's a new beginning.

126



127



GISELLE

Design:
R&D Twils

THE GOLDEN OPPORTUNITY YOU ARE SEEKING IS IN YOURSELF

LOOK IT UP

*Grazie al rivestimento tessile,
ogni letto Twils assume un preciso carattere,
definito dalla trama, dal colore, dall'aspetto
materico e dalle lavorazioni aggiunte.
Ogni letto Twils diventa espressione
di uno stile individuale, inimitabile e unico.*

*Thanks to the textile upholstery,
every Twils bed has its own precise
character that is defined by the weave,
colour, texture and extra finishes.
Every Twils bed expresses an individual,
inimitable and unique style.*



Name of bed:
Giselle h.28
~
Design:
R&D Twils

130

131



La testiera di Giselle è avvolta da due grandi cuscini morbidamente imbottiti, trattenuti sui lati esterni da un'ampia orlatura chiusa con eleganti bottoni rivestiti. La sua personalità è tutta in questo ricercato dettaglio sartoriale, che esprime armonia, spontaneità e stile.

The Giselle headboard is covered with two large softly padded cushions which are held in place on the outer edges by a generous trim with smart upholstered buttons. Its personality is captured in this exclusive bespoke detail which conveys harmony, spontaneity and style.



La semplicità è la nota fondamentale di ogni vera eleganza.

Simplicity is the keynote of all true elegance.

Coco Chanel



Name of bed:
Giselle con gonna
~
Design:
R&D Twils

134



135

*Ricorda che ci sarà sempre un'altra opportunità.
Un'altra amicizia. Un altro amore. Una nuova vita.*

*Remember that another chance may come up.
A new friend. A new love. A new life.*

Antoine de Saint-Exupéry

Giselle acquisisce un aspetto romantico e senza tempo con l'aggiunta di una morbida gonna in tessuto che sfiora il pavimento, rifinita con due pinces che decorano gli angoli frontali. Ogni dettaglio contribuisce all'armonia.

Giselle takes on timeless romantic appeal when fitted with a soft fabric valance which almost touches the floor and has two pleats on the front corners. Every detail adds to the harmonious whole.

136



137





L'eleganza ha dei codici intrinseci. È un connubio di portamento, attitudine e personalità. Prescinde dalle epoche e dalle mode correnti. È questione di scelte, di sincerità e naturalezza, di equilibrio e armonia. È tangibile e sfuggente.

Elegance has its own canons. It is a combination of posture, aptitude and personality. Regardless of eras and current trends. It's a question of choices, sincerity and naturalness, balance and harmony. It is tangible and fleeting.

Name:
Panchetta Coffè Capitoné 45x135
Coffè Capitoné bench 45x135
 ~
 Design:
R&D Twils





Dorian è un'antologia di dettagli pregiati, un esercizio riuscito di perizia artigianale. Lo dimostra la sapiente lavorazione capitonné a losanghe della testiera, delicatamente arcuata, che si chiude in un elegante ricciolo. L'armonia delle proporzioni, i tipici piedini a cipolla, i dettagli sartoriali: tutto concorre a delineare uno stile inconfondibile.

Dorian is an anthology of exquisite details, a successful exercise in artisan workmanship. Testimony of this is the exquisitely crafted diamond button tufting on the headboard which arches gently backwards and culminates in an elegant curl. The perfectly balanced proportions, the typical onion feet and the bespoke tailored details: everything combines to make an unmistakable style statement.

DORIAN

Design:
R&D Twils



Name of bed:
Dorian h. 28
~
Design:
R&D Twils

142

143





*Non sognare la tua vita,
vivi il tuo sogno.*

*Don't dream your life,
live your dream.*

L'aspetto signorile di Dorian è l'esito della rilettura in chiave contemporanea di alcuni intramontabili cliché. La scelta dei rivestimenti, della biancheria e degli accessori tessili è l'ulteriore passo per sottolineare la sua unicità.

The aristocratic appearance of the Dorian bed is the result of contemporary restyling of some timeless details. The choice of upholstery, bed linen and textile accessories just go to underline its unique nature.



La raffinata forma a ricciolo della testiera è solo uno dei tratti distintivi di Dorian. La sapiente lavorazione capitonné crea un opulento e ricco motivo a rombi regolari, sottolineato dalle ribattiture e scandito dai preziosi bottoni rivestiti. Un letto da protagonisti dello stile.

The refined curl on the headboard is just one of the standout features of Dorian. The exquisitely crafted button tufting creates a rich, opulent, regular diamond-shaped motif that is accentuated by the piping effect and gorgeous covered buttons. A real trendsetter's bed.

146



147



*Non c'è fine. Non c'è inizio.
C'è solo l'infinita passione per la vita.*

*There is no end. There is no beginning.
There is only the passion of life.*

148

Ogni prodotto Twils è il risultato di un percorso: la progettazione, la messa a punto del design, la ricerca di soluzioni innovative. Un mix di passione, esperienza e creatività: l'unione di questi requisiti è il nostro valore aggiunto.

Every Twils product is the culmination of a process: the design, the development of the project and the search for innovative solutions. A mixture of passion, experience and creativity, and this is our added value.



Name:
Poltrona Grand Hotel
Grand Hotel armchair
~
Design:
R&D Twils

149

CAMILLE

Design:
R&D Twils

150

151





Camille è un evergreen delle collezioni Twils: rappresenta il coté classico della nostra ricerca di design, la signorilità formale che trascende il tempo e le mode, il doveroso omaggio a una tradizione di stile che tutti consideriamo seduettiva e intramontabile.

Camille is an evergreen model in the Twils collections: it reflects the classic side of our design research, the formal class and elegance which stand the test of time and trends, a fitting tribute to a style tradition that we all consider seductive and timeless.

**IMAGINATION WILL GET
YOU EVERYWHERE.
YOU CAN**

Name of bed:
Camille Basso h.28
~
Design:
R&D Twils

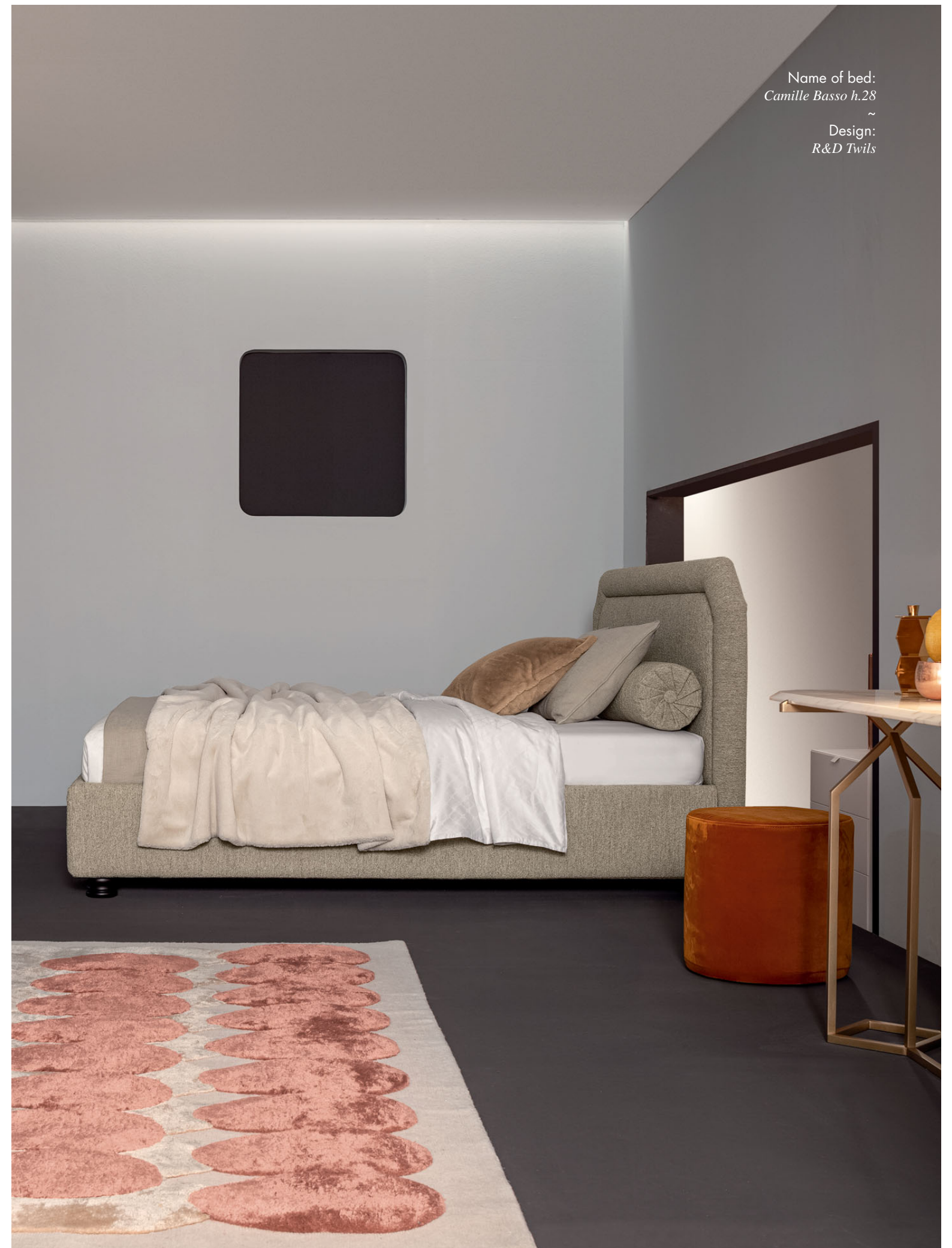

SOME THINGS ARE BETTER IN DREAMS

Le poltroncine Twils sono complementi versatili, capaci di affiancare ogni modello di letto, anche quelli di impronta classica come Camille. Un passe-partout di stile, che si inserisce in qualunque ambiente.

Twils armchairs are versatile accessories that complement all our beds, even those with more classical appeal like Camille. A stylish accessory that blends effortlessly into any room.

154

Name:
*Poltrona Charme Mini
Charme Mini armchair*
~
Design:
Studio Thesia Progetti



155

Name of bed:
Camille Alto Capitonné h. 28
~
Design:
R&D Twils

156



157



La preziosa lavorazione capitonné a losanghe arricchisce la testiera di Camille con suggestivi giochi di chiaroscuro. Un effetto scenico suggestivo e lussuoso, che attrae magneticamente il nostro sguardo.

The beautiful diamond button tufting on the Camille headboard creates stunning light and dark effects. This dramatic, engaging and luxurious feature draws our eyes like a magnet.



158

159

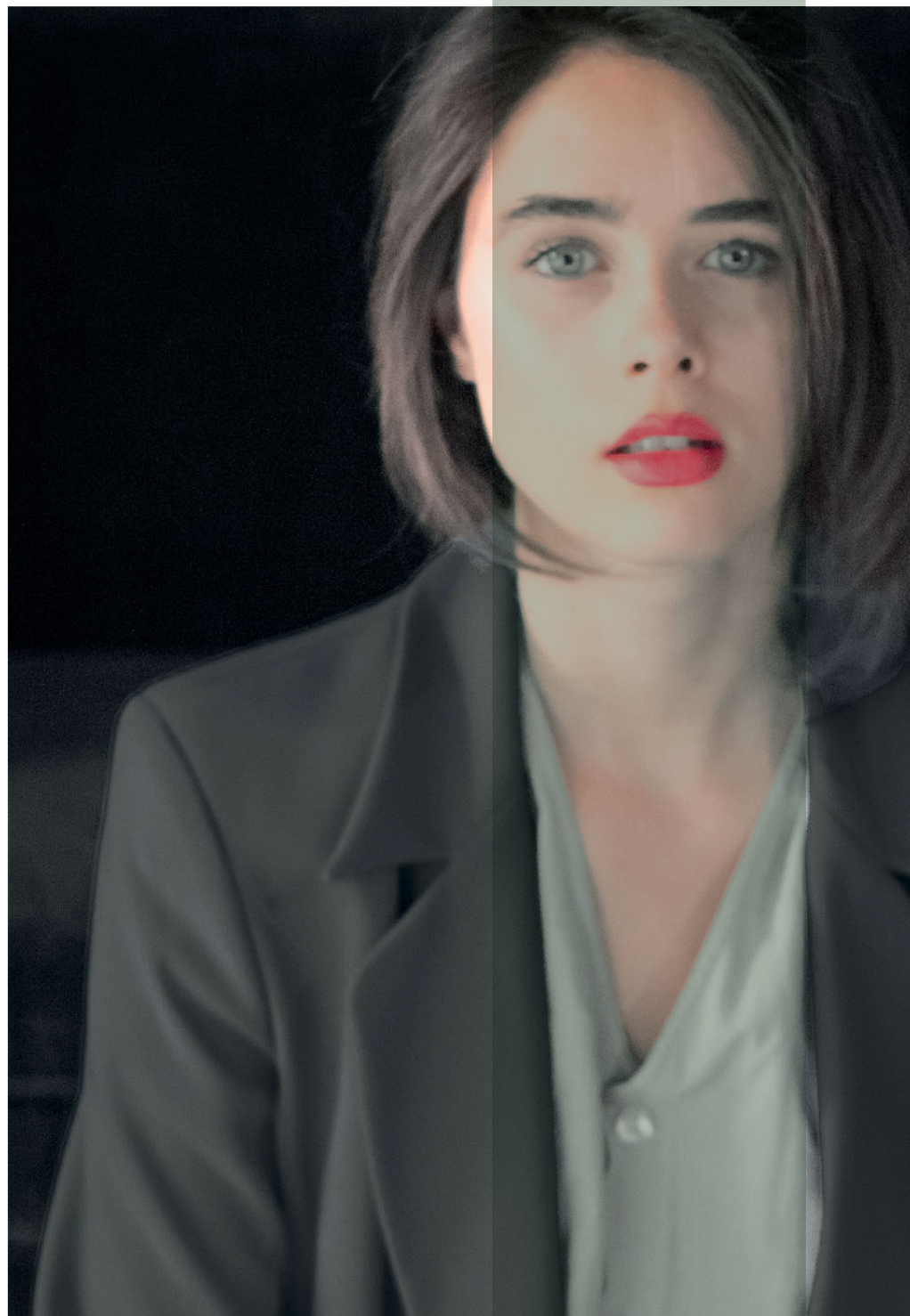

Non rinunciare a provare a fare
ciò che vuoi veramente fare.
Dove c'è amore e ispirazione,
non penso che si possa sbagliare.

*Just don't give up trying
to do what you really want to do.
Where there is love and inspiration,
I don't think you can go wrong.*

Ella Fitzgerald

Name:
Panchetta Coffe Capitonné 45x135
Coffe Capitonné bench 45x135

~
Design:
R&D Twils

Name:
Librerie Set Piccole
Set little bookcase

~
Design:
Studio Viganò



SOUL

Design:
R&D Twils

I morbidi cuscini oversize che compongono la testiera di Soul sono pensati per accogliere il vostro riposo dopo una giornata intensa. Un letto essenziale dai volumi rigorosi, di forte personalità, alleato ideale del comfort.

The soft oversized cushions on the Soul headboard are designed to lull you to sleep after a busy day. This minimal bed with its essential volumes and strong personality is just what you need for a comfortable night's sleep.

**CHANGE YOUR
THOUGHTS
AND YOU
CHANGE
YOUR WORLD**

162



163





Name of bed:
Soul h. 28
~
Design:
R&D Twils



166

**THE FUTURE IS YET
IN YOUR POWER.**
CHANGE



Scegliamo un letto in base alla nostra idea di stile, alle nostre esigenze pratiche, alla voglia di cambiamento. Siamo attratti dalle forme rassicuranti, dall'eleganza della linea, dalla promessa di comfort.

We choose a bed that matches our idea of style, our practical needs, our desire for change. We are drawn to reassuring shapes, elegant lines and the promise of comfort.



La testiera di Soul è leggermente inclinata per favorire il comfort. I due soffici cuscini possono essere inclinati individualmente grazie a un meccanismo non visibile, per adattarsi alla vostra posizione preferita.

The Soul headboard is slightly sloping for greater comfort. The two soft cushions can each be positioned at your favourite angle thanks to a concealed mechanism.

167

Name:
Poltrona Carnaby
Carnaby armchair
~
Design:
R&D Twils



168

EVERY END IS A NEW BEGINNING.

START

All'origine di ogni letto Twils c'è un sogno: quello di avverare i sogni di tutti. Per riuscirci servono passione, competenza, inventiva e la ricerca di forme, idee e soluzioni sempre nuove, attuali, performanti, perché sognare è un atto creativo, talvolta rivoluzionario.

Every Twils bed starts life as a dream: to make everyone else's dreams come true. To do this you need passion, skill and creativity, you need to seek out the latest, contemporary and high-performance shapes, ideas and solutions. Because dreaming is a creative and, at times, revolutionary act.

169

BOISERIE SET SLIM

Design:
Studio Viganò



170

Con i pannelli modulari della boiserie Set si creano pareti personalizzabili all'infinito, grazie a una componibilità semplice e razionale, favorita dalle diverse misure degli elementi. Grazie al ricchissimo campionario tessile Twils ogni composizione risulterà unica.

The Set modular panels allow you to create a never-ending number of personalised walls, thanks to their straightforward, rational modularity and different sized elements. And with the extensive Twils fabric selection, every composition is unique.



171

Name of bed:
Boiserie Set Slim e Ada Sommier 3Lati h. 14
~
Design:
Studio Viganò - R&D Twils





174

Alla boiserie può essere accostato un sommier rivestito con tessuti che riprendono quelli della composizione, con un effetto di elegante armonia. La sponda posteriore del giroletto ha uno spessore ridotto, che favorisce l'appoggio evitando che si formino inestetici spazi tra materasso e testiera.

A sommier can be placed up against the panels and upholstered in fabrics which match the wall composition for an elegant and harmonious effect. The back side of the bedstead is narrower than the others, so the bed can be placed against the wall without creating any unnecessary space between the mattress and the headboard.

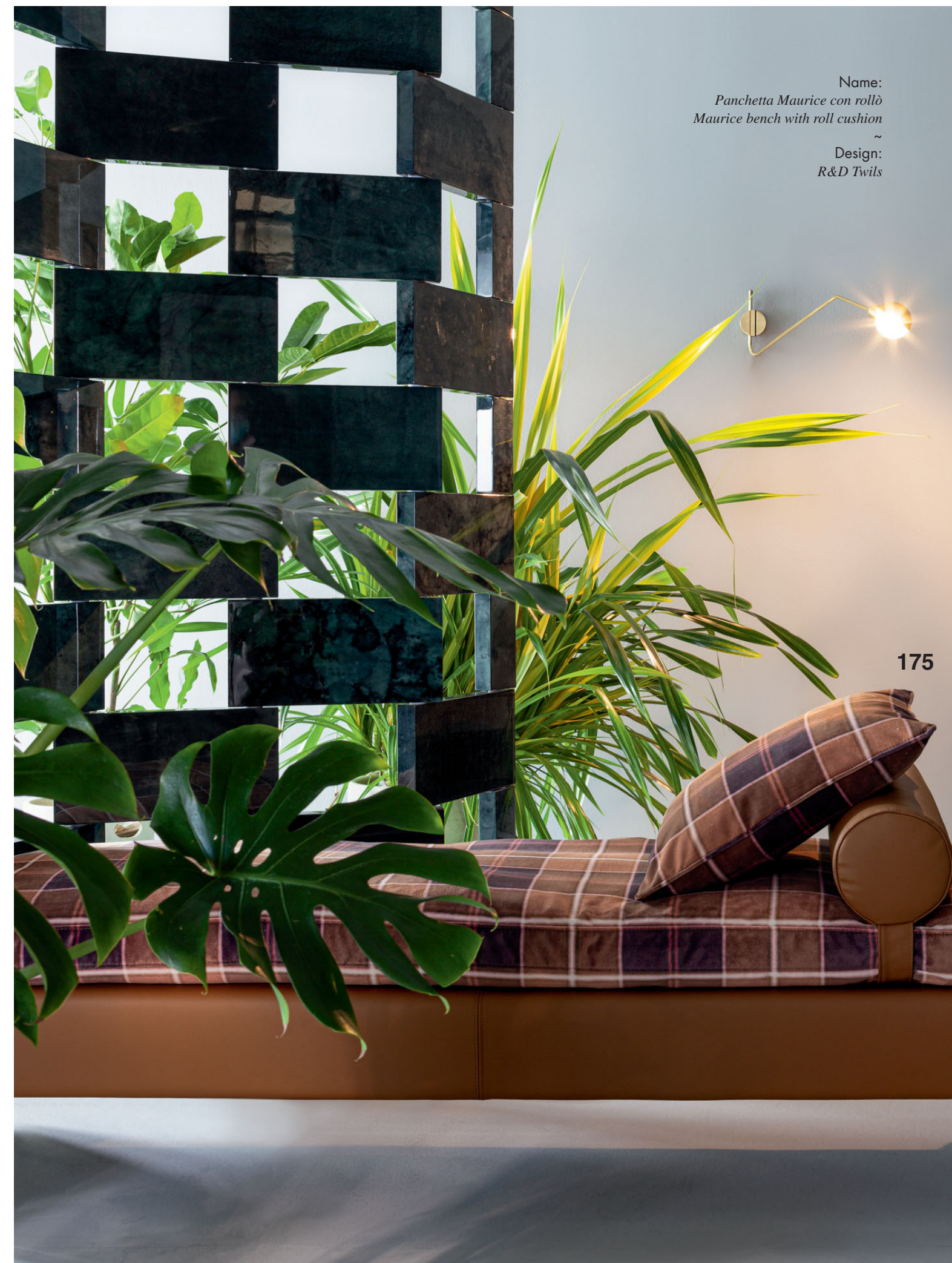

Name:
Panchetta Maurice con rollò
Maurice bench with roll cushion
~
Design:
R&D Twils

175



La parete può essere completata con mensole e punti luce appositamente concepiti; elementi semplici da integrare grazie a un sistema di aggancio sicuro e funzionale, per un comfort a 360°.

The wall can be accessorised with shelves and specially designed lights; these simple elements are easy to fit, thanks to a safe and practical hooking system that ensures maximum comfort.



Con la boiserie monocromatica e il sommier posizionato al centro della parete, la composizione assume uno spirito spiccatamente contemporaneo, temperato da un armonioso rigore formale.

With monochromatic panels and the sommier positioned centrally against the wall, the composition looks decidedly contemporary, complemented by its harmonious minimal style.



Name of bed:
Boiserie Set Slim e Ada Sommier 3Lati h. 14
~
Design:
Studio Viganò - R&D Twils

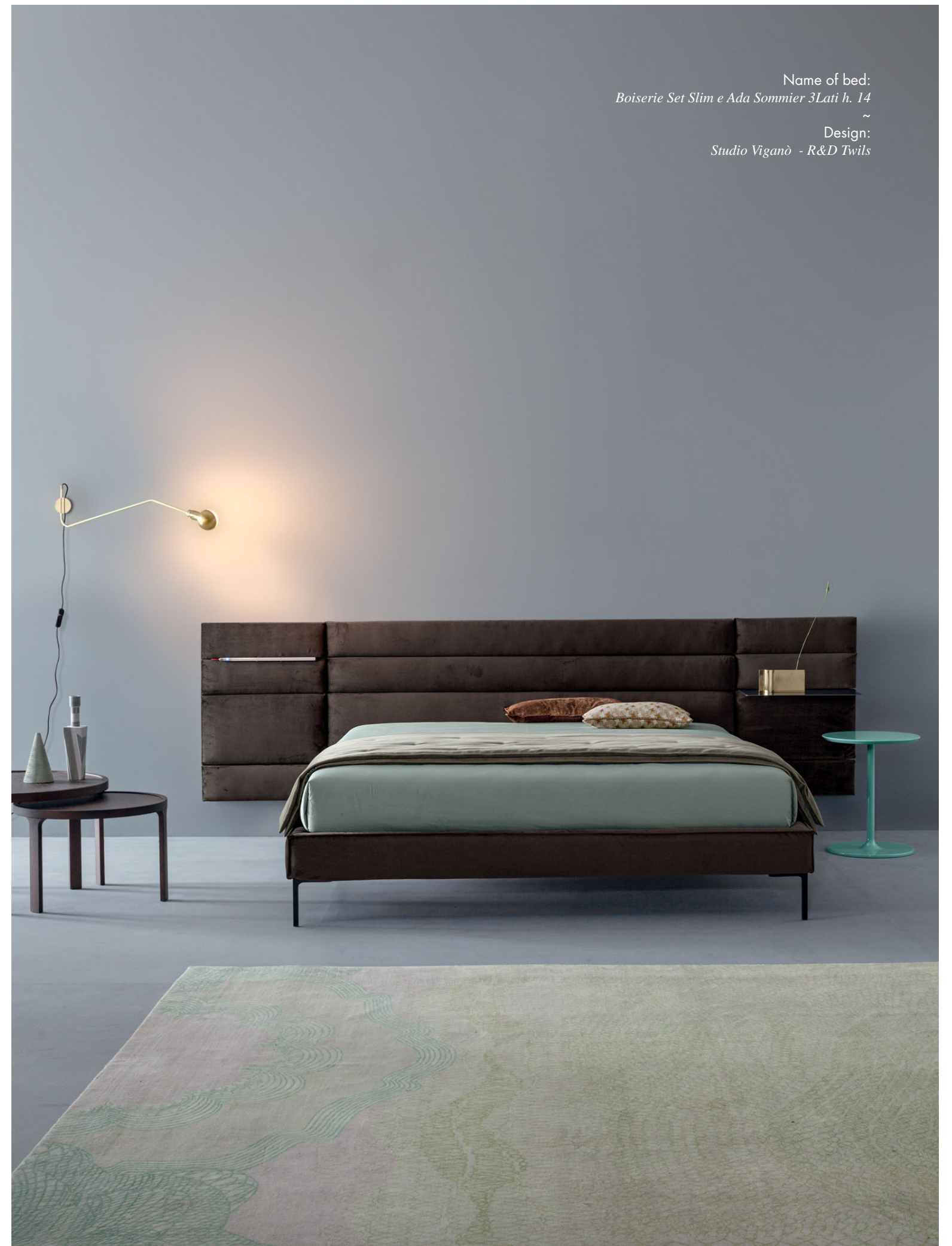

Forme contemporanee e stili classici si alternano in una collezione espressiva e completa. L'eleganza è data dall'equilibrio delle proporzioni, dall'armonia cromatica, dall'impeccabile confezione, dalla ricerca di innovative soluzioni estetiche e funzionali.

Contemporary shapes and classic styles rub shoulders in a highly expressive and complete collection. Elegance is ensured by the well-balanced proportions, matching colours, flawless workmanship and the search for innovative aesthetic and functional solutions.



**ALWAYS REMEMBER
THAT YOU ARE
ABSOLUTELY UNIQUE**



182

Un letto cosmopolita, di gusto minimal ma ricco di personalità e freschezza, progettato sull'equilibrio dei volumi e delle forme. Essenziale e creativo, eclettico e innovativo, Frick si rivolge ai millennial, agli eternamente giovani, a chi crede nella libertà d'espressione..

Frick is a cosmopolitan bed with a minimal design but plenty of personality and verve, designed to emphasize its harmonious volumes and shapes. Essential and creative, eclectic and innovative, Frick appeals to millennials, the Peter Pans among us and anyone who believes in freedom of expression.

FRICK

Design:
Meneghello & Paoletti associati



183

*Quando perdiamo il diritto di essere diversi,
perdiamo il privilegio di essere liberi.*

*When we lose the right to be different,
we lose the privilege to be free.*

Charles Evans Hughes



Name of bed:
Frick Basso h. 25
~
Design:
Meneghello & Paoelli associati



NEVER GO TO BED MAD

STAY UP

Il buon design si deve porre l'obiettivo di rendere le persone felici a livello funzionale, estetico, emozionale. La casa è l'espressione della nostra personalità, il posto dove possiamo e dobbiamo fare esperimenti creativi, concederci un capriccio, circondarci solo di cose che ci fanno stare bene.

The goal of good design is to make people happy on a practical, aesthetic and emotional level. Our home reflects our personality, it is the place where we can and must experiment creatively, satisfy our whims and surround ourselves with things that make us feel good.





Name of bed:
Frick Round h. 25
~
Design:
Meneghello & Paoletti associati



La testiera di Frick è composta da due pannelli imbottiti, fissati alla struttura grazie a un pratico sistema di aggancio interamente tessile. Il bordo rivestito è il dettaglio sartoriale che esprime lo stile Twils. Un letto contemporaneo, giovane, da rivestire con creatività.

The two padded panels on the Frick headboard are fixed to the structure by a practical hooking system that is completely upholstered. The piping seam is a bespoke detail synonymous of the Twils style. Release your creativity when upholstering this young, contemporary bed.





CHANGE YOUR THOUGHTS AND YOU CHANGE YOUR WORLD.

Una collezione ampia e ricca di idee, dove la ricerca estetica è sempre affiancata dall'attenzione alla funzionalità. Modelli concepiti oggi per diventare i classici di domani: il design di valore esprime le tendenze attuali per creare nuove icone di stile.

A complete collection packed with ideas, where research into aesthetics is always accompanied by attention to practical details. Today's models are designed to become tomorrow's classics: the top-quality design reflects the latest trends, creating new style icons.

Name:
Settimanale Tetris
Tetris chest of drawers
~
Design:
R&D Twils



MEDEA

Design:
R&D Twils

STUDY THE PAST IF YOU WOULD DEFINE THE FUTURE

NOW

Ci sono forme, stili e paradigmi che appartengono all'immaginario collettivo. Attraversano il tempo e le generazioni senza perdere la loro forza evocativa, la capacità di emozionarci, di rappresentare un ideale.

There are shapes, styles and paradigms that belong to popular imagination. They weather centuries and generations without losing any of their fascination and their ability to thrill us and stand for an ideal.

194



195



Name of bed:
Medea h. 28
~
Design:
R&D Twils

196



197





Una forma dolcemente arcuata, semplice ma inconfondibile, perché fissata nella nostra memoria. Medea è un letto sobrio e signorile, a suo agio anche negli ambienti di impronta contemporanea.

La scelta del rivestimento ne determina il carattere e lo stile.

This gently rounded shape is simple yet unmistakable because it is fixed in our memory. Medea is an understated, aristocratic bed that is also perfectly at home in contemporary settings.

The choice of upholstery determines its character and style.



*Chi guarda fuori, sogna.
Chi guarda dentro, si sveglia.*

*Who looks outside, dreams;
who looks inside, awakes.*

Solidità, funzionalità e comfort sono solo alcune caratteristiche che deve avere un letto di qualità. Stile, eleganza e precisione dei dettagli sono il valore aggiunto che Twils garantisce grazie all'esperienza e alla continua ricerca di nuove soluzioni.

Solid, practical and comfortable – these are just some of the features a top-quality bed should have. Style, elegance and attention to detail are the added values that Twils guarantees, thanks to its experience and ongoing search for new solutions.



200



201



202

FURNISHING ACCESSORIES



Name:
Pouf Quadrato con taglio vivo
Square footstool with raw edges
~
Size:
40x40 h.40 - 50x50 h.40 - 60x60 h.40
50x90 h.40 - 90x90 h.40
~
Design:
R&D Twils

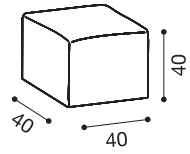

Name:
Pouf Soft Quadrato
Square Soft footstool
~
Size:
60x60 h.40 - 70x70 h.40
90x90 h.40
~
Design:
R&D Twils

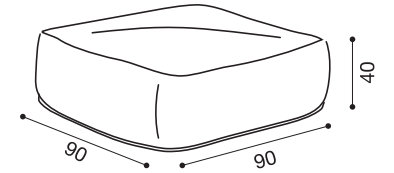

Name:
Pouf Quadrato
Square footstool
~
Size:
40x40 h.40 - 50x50 h.40 - 60x60 h.40
50x90 h.40 - 90x90 h.40
~
Design:
R&D Twils

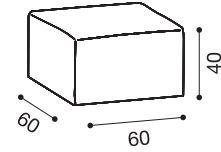

Name:
Pouf Soft Rotondo
Round Soft footstool
~
Size:
ø 60 h.40 - ø 70 h.40
ø 85 h.40
~
Design:
R&D Twils

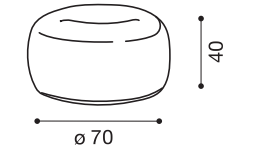

Name:
Pouf Rotondo
Round footstool
~
Size:
ø 40 h.40 - ø 50 h.40 - ø 60 h.40
ø 70 h.40 - ø 90 h.40
~
Design:
R&D Twils

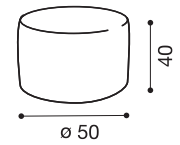

Name:
Pouf Clove Decor
Clove Decor footstool
~
Size:
ø 65 h.40 - ø 80 h.40
ø 100 h.40
~
Design:
Silvia Prevedello

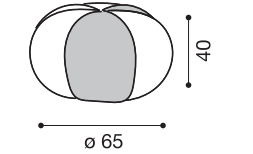

Name:
Pouf Nesos
Nesos footstool
~
Design:
R&D Twils

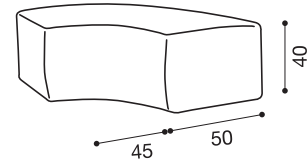

Name:
Pouf Clove
Clove footstool
~
Size:
ø 65 h.40 - ø 80 h.40
ø 100 h.40
~
Design:
Silvia Prevedello

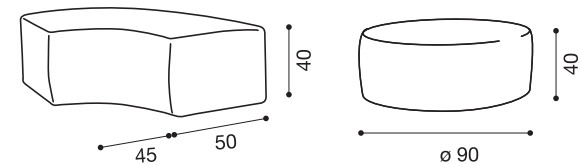
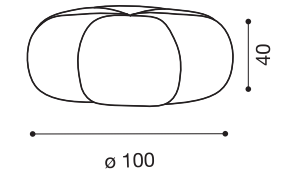

Name:
Pouf Modern
Modern footstool
~
Design:
R&D Twils

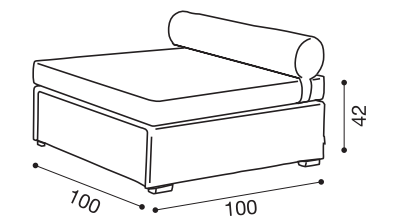

Name:
Pouf Seipersei
Seipersei footstool
~
Size:
100x86,6 h.42
160x138,6 h.42
~
Design:
Baldessari & Baldessari

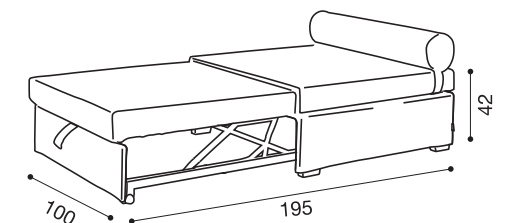
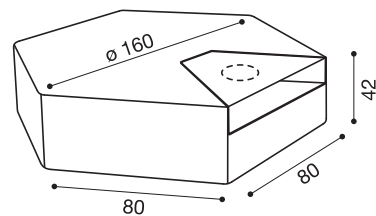



Name:
Pouf Albert
Albert footstool
~
Design:
R&D Twils

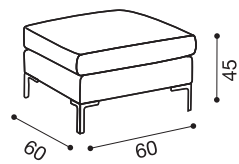

Name:
Panchetta Loulou
Loulou bench
~
Design:
R&D Twils

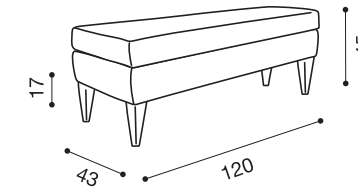

Name:
Pouf Condé
Condé footstool
~
Design:
Silvia Prevedello

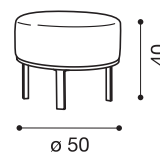

Name:
Panchetta Carmen
Carmen bench
~
Design:
R&D Twils

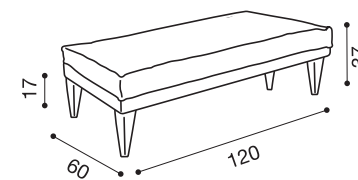

Name:
Pouf Adam
Adam footstool
~
Design:
R&D Twils

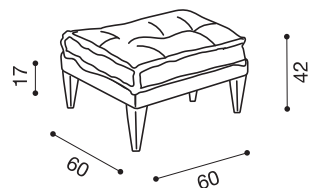

Name:
Panchetta Legend
Legend bench
~
Design:
Cairolì & Donzelli

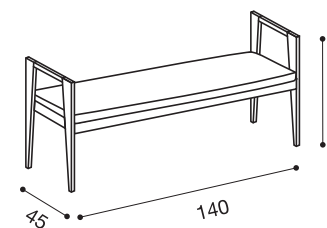

Name:
Panchetta Adam
Adam bench
~
Design:
R&D Twils

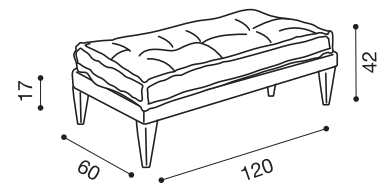

Name:
Panchetta Oscar
Oscar bench
~
Design:
R&D Twils

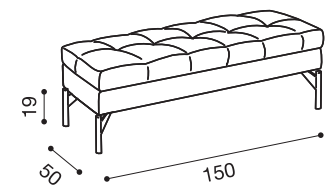

Name:
Materasso trapuntato
Quilted mattress
~
Size:
60x60 h.15 - 60x120 h.15
80x190 h.15 - 90x200 h.15
~
Design:
R&D Twils

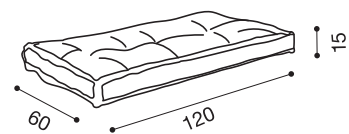

Name:
Panchetta Maurice
Maurice bench
~
Design:
R&D Twils

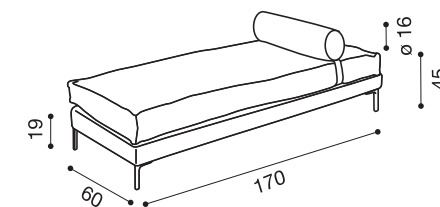

Name:
Panchetta Luise
Luise bench
~
Design:
R&D Twils

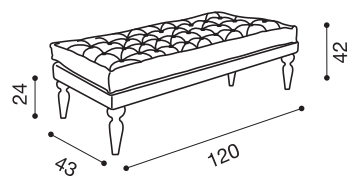



Name:
Pouf Coffe
Coffe footstool
~
Size:
45x45 h.42
~
Design:
R&D Twils

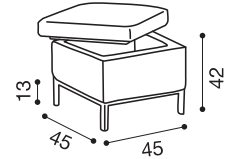

Name:
Pouf Contentore
Storage footstool
~
Size:
40x40 h.45 - 50x50 h.45
~
Design:
R&D Twils

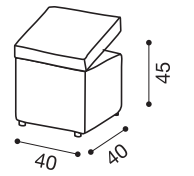

Name:
Panchetta Coffe
Coffe bench
~
Size:
90x45 h.42
~
Design:
R&D Twils

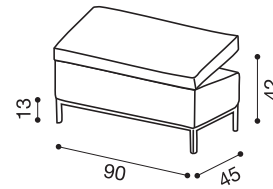

Name:
Panchetta Contentore
Storage bench
~
Size:
100x50 h.45
~
Design:
R&D Twils

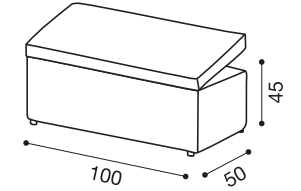

Name:
Panchetta Coffe
Coffe bench
~
Size:
135x45 h.47
~
Design:
R&D Twils

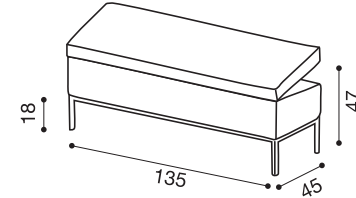

Name:
Sedia Cocò
Cocò chair
~
Design:
R&D Twils

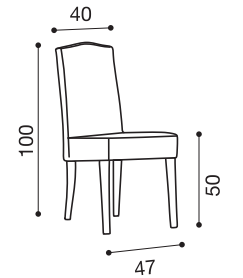

Name:
Pouf Coffe Capitoné
Coffe Capitoné footstool
~
Size:
45x45 h.46
~
Design:
R&D Twils

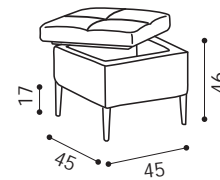

Name:
Sedia Sally
Sally chair
~
Design:
R&D Twils

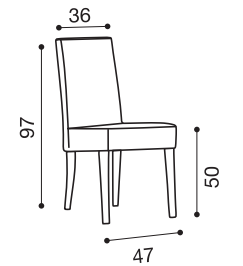

Name:
Panchetta Coffe Capitoné
Coffe Capitoné bench
~
Size:
90x45 h.46
~
Design:
R&D Twils

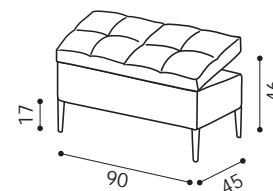

Name:
Sedia Sally o Cocò con gonna lunga
Sally or Cocò chair with long valance
~
Information:
Realizzabile solo con tessuto di lino
Only available in linen fabric
~
Design:
R&D Twils

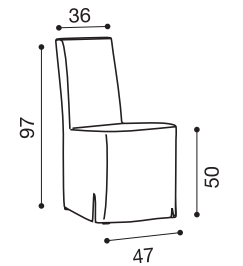

Name:
Panchetta Coffe Capitoné
Coffe Capitoné bench
~
Size:
135x45 h.46
~
Design:
R&D Twils

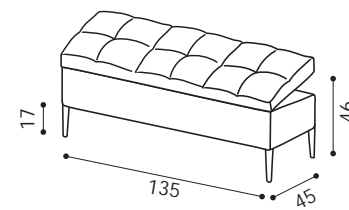

Name:
Poltrona Ramses
Ramses armchair
~
Design:
ADD Angelo Dall'Aglio

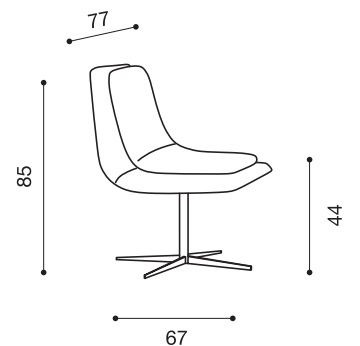



Name:
Poltrona Carnaby
Carnaby armchair
~
Design:
R&D Twils

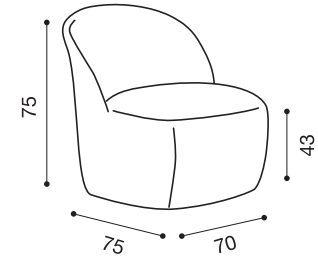

Name:
Poltrona Colette
Colette armchair
~
Design:
Antonio Fattore

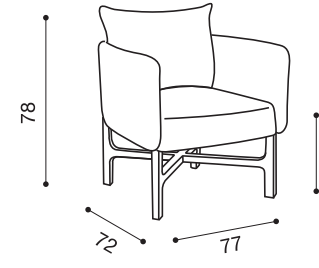

Name:
Poltrona Tea
Tea armchair
~
Design:
R&D Twils

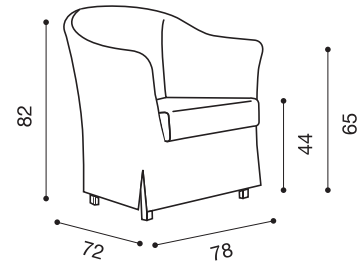

Name:
Poltrona Grand Hotel
Grand Hotel armchair
~
Design:
R&D Twils

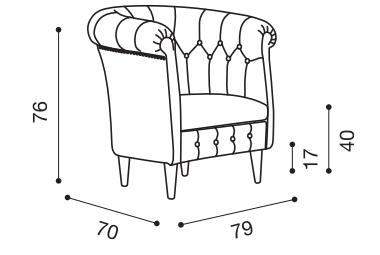

Name:
Poltrona Charme Mini
Charme Mini armchair
~
Design:
Studio Thesia Progetti

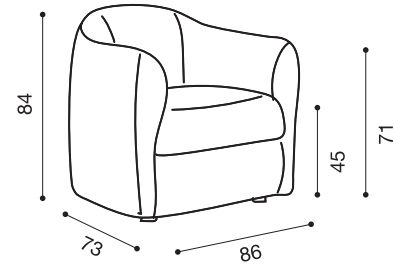

Name:
Poltrona Revival Mini
Revival Mini armchair
~
Design:
R&D Twils

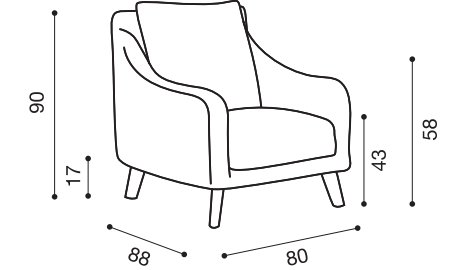

Name:
Poltrona Kondi Mini
Kondi Mini armchair
~
Design:
R&D Twils

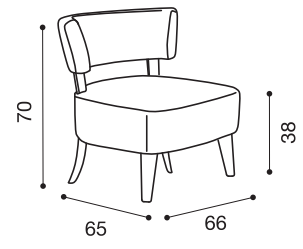

Name:
Poltrona Lucas
Lucas armchair
~
Size:
75x76 h.75
~
Design:
R&D Twils

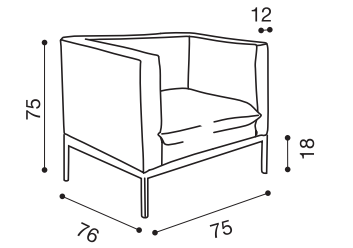

Name:
Poltrona Kondi
Kondi armchair
~
Design:
R&D Twils

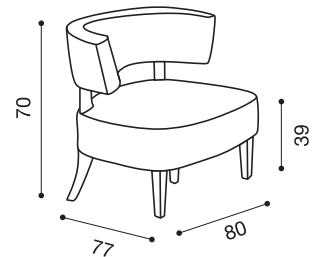

Name:
Divano Lucas
Lucas sofà
~
Size:
130x76 h.75
~
Design:
R&D Twils

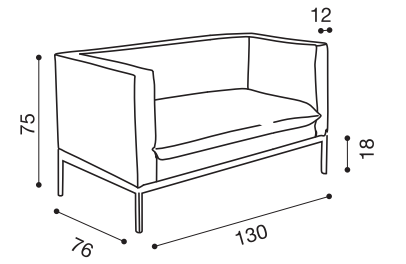

Name:
Poltrona Deseret
Deseret armchair
~
Design:
Antonio Fattore

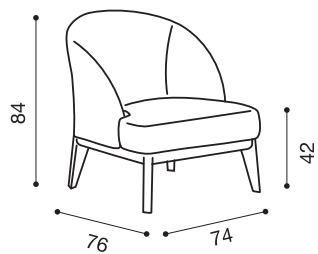

Name:
Divano Lucas
Lucas sofà
~
Size:
170x76 h.75
~
Design:
R&D Twils

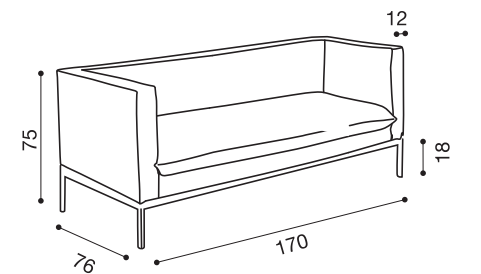



Name:
Tavolino Condé
Condé table
~
Size:
Ø60 h.40
~
Design:
Silvia Prevedello

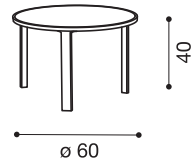

Name:
Tavolino Condé
Condé table
~
Size:
Ø80 h.46
~
Design:
Silvia Prevedello

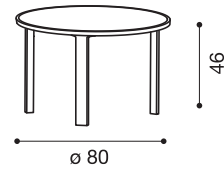

Name:
Tavolino Simplit
Simplit table
~
Size:
Ø45 h.45 - Ø60 h.45
~
Design:
Bottino & Tinti

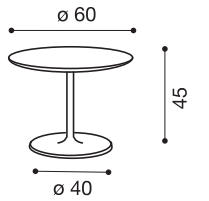

Name:
Tavolino Simplit
Simplit table
~
Size:
Ø45 h.55 - Ø60 h.55
~
Design:
Bottino & Tinti

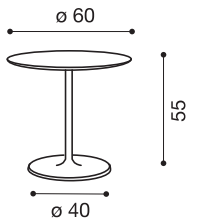

Name:
Tavolino Simplit
Simplit table
~
Size:
Ø45 h.72 - Ø60 h.72
Ø80 h.72
~
Design:
Bottino & Tinti

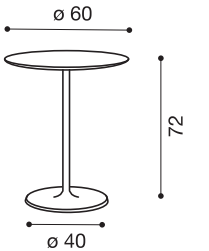

Name:
Servetto Condé
Condé side table
~
Design:
Silvia Prevedello

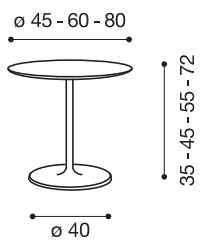
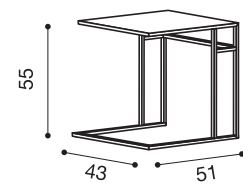

Name:
Libreria Set Piccola
Set little bookcase
~
Size:
33x33 h.64
~
Design:
Studio Viganò

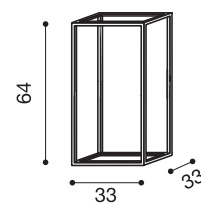

Name:
Libreria Set
Set bookcase
~
Size:
96x96 s.33
~
Design:
Studio Viganò

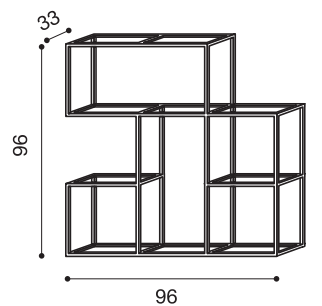

Name:
Libreria Set Piccola
Set little bookcase
~
Size:
64x33 h.33
~
Design:
Studio Viganò

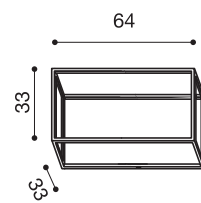

Name:
Ripiano Libreria Set
Set shelf for bookcase
~
Size:
31,4x31,4



Name:
*Comodino Tetris
Tetris nightstands*
~
Size:
55x43 h.25
~
Design:
Cairolì & Donzelli

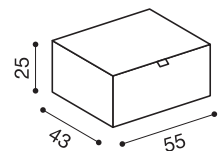

Name:
*Comodino Tetris
Tetris nightstands*
~
Size:
55x43 h.51
~
Design:
Cairolì & Donzelli

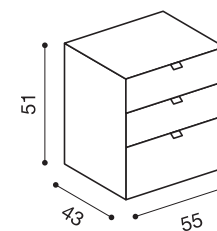

Name:
*Comodino Tetris
Tetris nightstands*
~
Size:
85x43 h.25
~
Design:
Cairolì & Donzelli

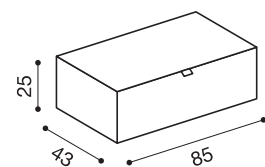

Name:
*Comò Tetris
Tetris chest of drawers*
~
Size:
130x52 h.71,5
~
Design:
Cairolì & Donzelli

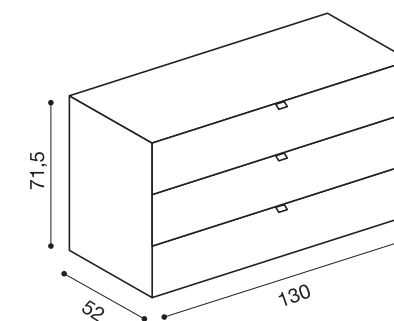

Name:
*Comodino Tetris
Tetris nightstands*
~
Size:
55x43 h.41
~
Design:
Cairolì & Donzelli

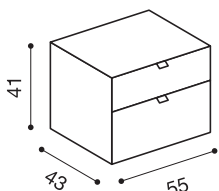

Name:
*Settimanale Tetris
Tetris chest of drawers*
~
Size:
55x43 h.125,6
~
Design:
Cairolì & Donzelli

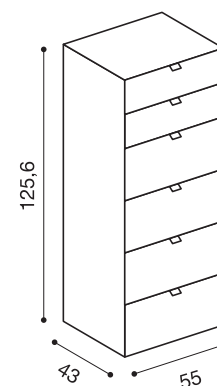

Name:
*Comodino Tetris
Tetris nightstands*
~
Size:
85x43 h.48
~
Design:
Cairolì & Donzelli

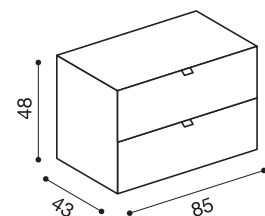



Twils[®]



Attico h.14
Pag. 9

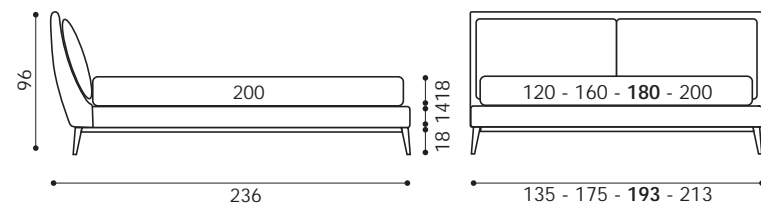

- | | | |
|--|--------------|-----------|
| 1 Letto Attico matrimoniale 180x200 cm
Giroletto h. 14
Piede PIEMAXZ | Art. D58/048 | Cat. K |
| 1 Completo copripiumino matrimoniale 180 cm | Art. B66/016 | Cat. Z |
| 1 Piumotto 230x140 cm 120 gr/m ² | Art. 969/097 | Cat. Must |
| 1 Cuscino 50x50 cm mod. B | Art. D81/006 | Cat. Must |
| 1 Cuscino 50x50 cm mod. B | Art. 969/097 | Cat. Must |
| 1 Bordo rivestito | Art. C10/008 | Cat. K |
| 1 Cuscino 50x50 cm mod. B | Art. C10/012 | Cat. K |
| 1 Cuscino 50x50 cm mod. B | Art. D79/001 | Cat. K |

- | | | |
|--|--|--|
| 1 Double bed Attico 180x200 cm
Bedframe h. 14
Legs PIEMAXZ | | |
| 1 Duvet cover set for double bed 180 cm | | |
| 1 Padded throw 230x140 cm 120 gr/m ² | | |
| 1 Cushion 50x50 cm mod. B | | |
| 1 Cushion 50x50 cm mod. B | | |
| 1 Piped edge | | |
| 1 Cushion 50x50 cm mod. B | | |
| 1 Cushion 50x50 cm mod. B | | |

- | | | |
|---|--|--|
| 1 Doppelbett Attico 180x200 cm
Rahmen h. 14
Fuß PIEMAXZ | | |
| 1 Bettbezug-Set für Doppelbett 180 cm | | |
| 1 Gestepte Tagesdecke 230x140 cm 120 gr/m ² | | |
| 1 Kissen 50x50 cm Mod. B | | |
| 1 Kissen 50x50 cm Mod. B | | |
| 1 Keder | | |
| 1 Kissen 50x50 cm Mod. B | | |
| 1 Kissen 50x50 cm Mod. B | | |

- | | | |
|--|--|--|
| 1 Lit Attico double 180x200 cm
Cadre h. 14
Pieds PIEMAXZ | | |
| 1 Parure housse de couette double 180 cm | | |
| 1 Couette 230x140 cm 120 gr/m ² | | |
| 1 Coussin 50x50 cm mod. B | | |
| 1 Coussin 50x50 cm mod. B | | |
| 1 Bord revêtu | | |
| 1 Coussin 50x50 cm mod. B | | |
| 1 Coussin 50x50 cm mod. B | | |

- | | | |
|---|--|--|
| 1 Cama Attico 180x200 cm
Aro de cama h. 14
Pata PIEMAXZ | | |
| 1 Conjunto de funda nórdica para cama doble 180 cm | | |
| 1 Manta Acolchada 230x140 cm 120 gr/m ² | | |
| 1 Cojín 50x50 cm mod. B | | |
| 1 Cojín 50x50 cm mod. B | | |
| 1 Bordo revestido | | |
| 1 Cojín 50x50 cm mod. B | | |
| 1 Cojín 50x50 cm mod. B | | |



Attico h. 28
Pag. 17

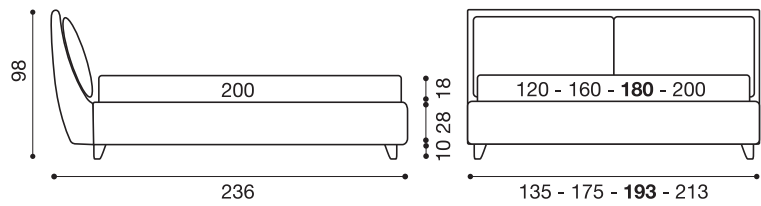

- | | | |
|---|------------------------------|--------------------------|
| 1 Letto Attico matrimoniale 180x200 cm
Cuscini Testiera
Giroletto h. 28
Piede PIE40L | Art. D73/005
Art. D59/002 | Cat. Luxury
Cat. Must |
| 1 Completo copripiumino matrimoniale 180 cm | Art. 990/042 | Cat. Z |
| 1 Piumotto 230x140 cm 120 gr/m ² | Art. C10/012 | Cat. K |
| 1 Copriletto Liscio 260x140 cm | Art. D79/003 | Cat. K |
| 1 Cuscino 50x50 cm con cucitura pinzata | Art. D79/004 | Cat. K |
| 1 Cuscino 50x50 cm mod. B | Art. 969/031 | Cat. Must |
| 1 Cuscino 70x40 cm mod. B | Art. C10/015 | Cat. K |
| 1 Cuscino 70x40 cm mod. B | Art. 969/037 | Cat. Must |

- | | | |
|---|--|--|
| 1 Double bed Attico 180x200 cm
Headboard cushions
Bedframe h. 28
Legs PIE40L | | |
| 1 Duvet cover set for double bed 180 cm | | |
| 1 Padded throw 230x140 cm 120 gr/m ² | | |
| 1 Bedspread plain 260x140 cm | | |
| 1 Cushion 50x50 cm with gathered stitching | | |
| 1 Cushion 50x50 cm mod. B | | |
| 1 Cushion 70x40 cm mod. B | | |
| 1 Cushion 70x40 cm mod. B | | |

- | | | |
|---|--|--|
| 1 Doppelbett Attico 180x200 cm
Bettkissen
Bedrahmen h. 28
Fuß PIE40L | | |
| 1 Bettbezug-Set für Doppelbett 180 cm | | |
| 1 Gestepte Tagesdecke 230x140 cm 120 gr/m ² | | |
| 1 Tagesdecke glatt 260x140 cm | | |
| 1 Kissen 50x50 cm mit offener Naht | | |
| 1 Kissen 50x50 cm Mod. B | | |
| 1 Kissen 70x40 cm Mod. B | | |
| 1 Kissen 70x40 cm Mod. B | | |

- | | | |
|--|--|--|
| 1 Lit Attico double 180x200 cm
Coussin tête de lit
Cadre h. 28
Pieds PIE40L | | |
| 1 Parure housse de couette double 180 cm | | |
| 1 Couette 230x140 cm 120 gr/m ² | | |
| 1 Dessus de lit lisse 260x140 cm | | |
| 1 Coussin 50x50 cm a/couture francée | | |
| 1 Coussin 50x50 cm mod. B | | |
| 1 Coussin 70x40 cm mod. B | | |
| 1 Coussin 70x40 cm mod. B | | |

- | | | |
|--|--|--|
| 1 Cama Attico 180x200 cm
Cojines cabecero
Aro de cama h. 28
Pata PIE40L | | |
| 1 Conjunto de funda nórdica para cama doble 180 cm | | |
| 1 Manta Acolchada 230x140 cm 120 gr/m ² | | |
| 1 Cubrecama 260x140 cm | | |
| 1 Cojín 50x50 cm costura grapada | | |
| 1 Cojín 50x50 cm mod. B | | |
| 1 Cojín 70x40 cm mod. B | | |
| 1 Cojín 70x40 cm mod. B | | |



Calvin h. 25
Pag. 25

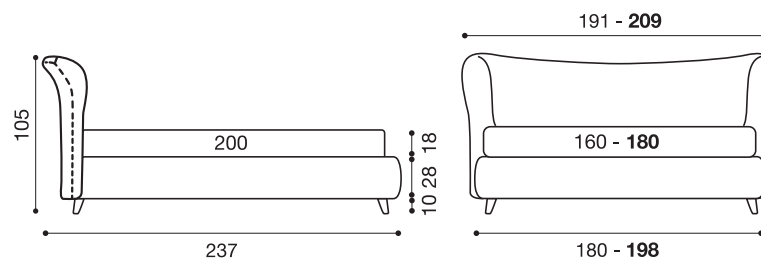

- | | | |
|---|--------------|-------------|
| 1 Letto Calvin matrimoniale 180x200 cm
Giroletto h. 25
Piede PIE38V | Art. D67/002 | Cat. Luxury |
| 2 Rollo' con cerniera e bordo rivestito da 90 cm | Art. 969/031 | Cat. Must |
| 1 Completo copripiumino matrimoniale 180 cm | Art. 990/020 | Cat. Y |
| 1 Piumotto 230x140 cm 120 gr/m ² | Art. 969/070 | Cat. Must |
| 1 Cuscino 50x30 cm mod. B | Art. A64/028 | Cat. Must |
| 1 Cuscino 70x40 cm con cucitura pinzata | Art. D45/011 | Cat. K |
| 1 Cuscino 50x30 cm mod. B | Art. D83/004 | Cat. K |
| 1 Cuscino 50x30 cm mod. B | Art. D83/005 | Cat. K |

- | | | |
|---|--|--|
| 1 Double bed Calvin 180x200 cm
Bedframe h. 25
Legs PIE38V | | |
| 2 Roll cushion with zip and piped edge 90 cm | | |
| 1 Duvet cover set for double bed 180 cm | | |
| 1 Padded throw 230x140 cm 120 gr/m ² | | |
| 1 Cushion 50x30 cm mod. B | | |
| 1 Cushion 70x40 cm with gathered stitching | | |
| 1 Cushion 50x30 cm mod. B | | |
| 1 Cushion 50x30 cm mod. B | | |

- | | | |
|--|--|--|
| 1 Doppelbett Calvin 180x200 cm
Rahmen h. 25
Fuß PIE38V | | |
| 2 Kissenrollen mit Reißverschluss und Keder 90 cm | | |
| 1 Bettlaken-Set für Doppelbett 180 cm | | |
| 1 Gestepte Tagesdecke 230x140 cm 120 gr/m ² | | |
| 1 Kissen 50x30 cm Mod. B | | |
| 1 Kissen 70x40 cm mit offener Naht | | |
| 1 Kissen 50x30 cm Mod. B | | |
| 1 Kissen 50x30 cm Mod. B | | |

- | | | |
|---|--|--|
| 1 Lit Calvin double 180x200 cm
Cadre h. 25
Pieds PIE38V | | |
| 2 Rollo' avec charnière et bord revêtu 90 cm | | |
| 1 Parure housse de couette double 180 cm | | |
| 1 Couette 230x140 cm 120 gr/m ² | | |
| 1 Coussin 50x30 cm mod. B | | |
| 1 Coussin 70x40 cm a/couture francée | | |
| 1 Coussin 50x30 cm mod. B | | |
| 1 Coussin 50x30 cm mod. B | | |

- | | | |
|--|--|--|
| 1 Cama Calvin 180x200 cm
Aro de cama h. 25
Pata PIE38V | | |
| 2 Cojín cilíndrico con cremallera y borde revestido 90 cm | | |
| 1 Conjunto de funda nórdica para cama doble 180 cm | | |
| 1 Manta Acolchada 230x140 cm 120 gr/m ² | | |
| 1 Cojín 50x30 cm mod. B | | |
| 1 Cojín 70x40 cm costura grapada | | |
| 1 Cojín 50x30 cm mod. B | | |
| 1 Cojín 50x30 cm mod. B | | |

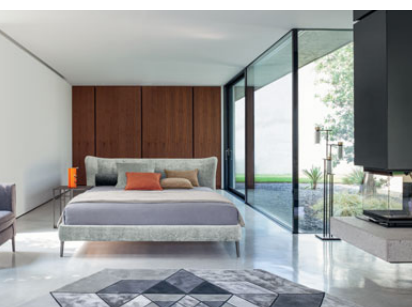

Calvin h.15
Pag. 33

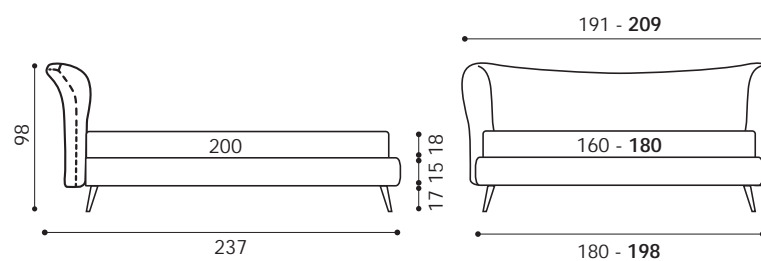

- | | | |
|---|--------------|-----------|
| 1 Letto Calvin matrimoniale 180x200 cm
Giroletto h. 15
Piede PIE69Z | Art. C10/010 | Cat. K |
| 2 Rollo' con cerniera da 90 cm | Art. C10/023 | Cat. K |
| 1 Completo copripiumino matrimoniale 180 cm | Art. B66/012 | Cat. Z |
| 1 Piumotto 230x140 cm 120 gr/m ² | Art. 969/033 | Cat. Must |
| 1 Cuscino 50x30 cm con cucitura pinzata | Art. D58/099 | Cat. K |
| 1 Cuscino 50x50 cm con cucitura pinzata | Art. D58/099 | Cat. K |
| 1 Cuscino 50x50 cm con cucitura pinzata | Art. C40/007 | Cat. Must |
| 1 Cuscino 60x60 cm con cucitura pinzata | Art. C10/010 | Cat. K |

- | | | |
|---|--|--|
| 1 Double bed Calvin 180x200 cm
Bedframe h. 15
Legs PIE69Z | | |
| 2 Roll cushion with zip 90 cm | | |
| 1 Duvet cover set for double bed 180 cm | | |
| 1 Padded throw 230x140 cm 120 gr/m ² | | |
| 1 Cushion 50x30 cm with gathered stitching | | |
| 1 Cushion 50x50 cm with gathered stitching | | |
| 1 Cushion 50x50 cm with gathered stitching | | |
| 1 Cushion 60x60 cm with gathered stitching | | |

- | | | |
|--|--|--|
| 1 Doppelbett Calvin 180x200 cm
Rahmen h. 15
Fuß PIE69Z | | |
| 2 Kissenrolle mit Reißverschluss 90 cm | | |
| 1 Bettbezug-Set für Doppelbett 180 cm | | |
| 1 Gestepte Tagesdecke 230x140 cm 120 gr/m ² | | |
| 1 Kissen 50x30 cm mit offener Naht | | |
| 1 Kissen 50x50 cm mit offener Naht | | |
| 1 Kissen 50x50 cm mit offener Naht | | |
| 1 Kissen 60x60 cm mit offener Naht | | |

- | | | |
|---|--|--|
| 1 Lit Calvin double 180x200 cm
Cadre h. 15
Pieds PIE69Z | | |
| 2 Rollo' avec charnière da 90 cm | | |
| 1 Parure housse de couette double 180 cm | | |
| 1 Couette 230x140 cm 120 gr/m ² | | |
| 1 Coussin 50x30 cm mod. B | | |
| 1 Coussin 50x50 cm a/couture francée | | |
| 1 Coussin 50x50 cm a/couture francée | | |
| 1 Coussin 60x60 cm a/couture francée | | |

- | | | |
|--|--|--|
| 1 Cama Calvin 180x200 cm
Aro de cama h. 15
Pata PIE69Z | | |
| 2 Cojín cilíndrico con cremallera 90 cm | | |
| 1 Conjunto de funda nórdica para cama doble 180 cm | | |
| 1 Manta Acolchada 230x140 cm 120 gr/m ² | | |
| 1 Cojín 50x30 cm costura grapada | | |
| 1 Cojín 50x50 cm costura grapada | | |
| 1 Cojín 50x50 cm costura grapada | | |
| 1 Cojín 60x60 cm costura grapada | | |



Philip Basso h. 28
Pag. 41

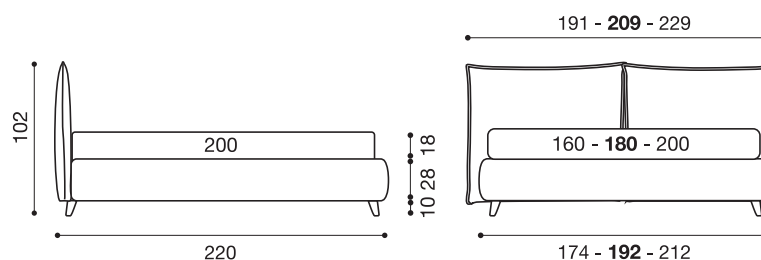

- | | | |
|---|--------------|-----------|
| 1 Letto Philip Basso matrimoniale 180x200 cm
Giroletto h. 28
Piede PIE38V | Art. D57/018 | Cat. Must |
| 1 Completo copripiumino matrimoniale 180 cm | Art. 991/047 | Cat. Y |
| 1 Piumotto 230x140 cm 120 gr/m ² | Art. D63/002 | Cat. Must |
| 1 Double | Art. 969/098 | Cat. Must |
| 1 Cuscino 50x50 cm mod. B | Art. D45/018 | Cat. K |
| 1 Cuscino 50x50 cm con cucitura pinzata | Art. 969/016 | Cat. Must |
| 1 Cuscino 50x50 cm mod. B | Art. D82/003 | Cat. Must |

- | | | |
|---|--|--|
| 1 Double bed Philip Basso 180x200 cm
Bedframe h. 28
Legs PIE38V | | |
| 1 Duvet cover set for double bed 180 cm | | |
| 1 Padded throw 230x140 cm 120 gr/m ² | | |
| 1 Double | | |
| 1 Cushion 50x50 cm mod. B | | |
| 1 Cushion 50x50 cm with gathered stitching | | |
| 1 Cushion 50x50 cm mod. B | | |

- | | | |
|--|--|--|
| 1 Doppelbett Philip Basso 180x200 cm
Rahmen h. 28
Fuß PIE38V | | |
| 1 Bettbezug-Set für Doppelbett 180 cm | | |
| 1 Gestepte Tagesdecke 230x140 cm 120 gr/m ² | | |
| 1 Double | | |
| 1 Kissen 50x50 cm Mod. B | | |
| 1 Kissen 50x50 cm mit offener Naht | | |
| 1 Kissen 50x50 cm Mod. B | | |

- | | | |
|---|--|--|
| 1 Lit Philip Basso double 180x200 cm
Cadre h. 28
Pieds PIE38V | | |
| 1 Parure housse de couette double 180 cm | | |
| 1 Couette 230x140 cm 120 gr/m ² | | |
| 1 Double | | |
| 1 Coussin 50x50 cm mod. B | | |
| 1 Coussin 50x50 cm a/couture francée | | |
| 1 Coussin 50x50 cm mod. B | | |

- | | | |
|--|--|--|
| 1 Cama Philip Basso 180x200 cm
Aro de cama h. 28
Pata PIE38V | | |
| 1 Conjunto de funda nórdica para cama doble 180 cm | | |
| 1 Piumotto 230x140 cm 120 gr/m ² | | |
| 1 Double | | |
| 1 Cojín 50x50 cm mod. B | | |
| 1 Cojín 50x50 cm costura grapada | | |
| 1 Cojín 50x50 cm mod. B | | |



Philip Basso con gonna

Pag. 43

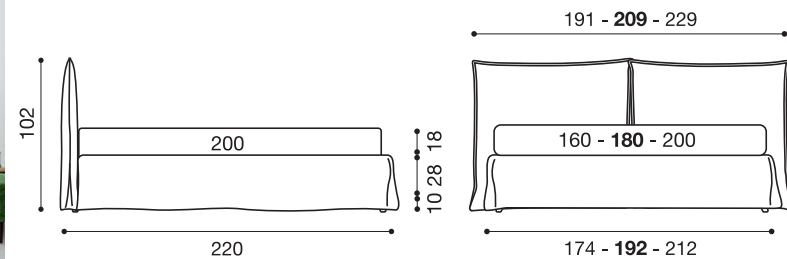

- 1 Letto Philip Basso matrimoniale 180x200 cm Art. D57/018 Cat. Must
Giroletto con gonna
Piede PIE38V
- 1 Completo copripiumino matrimoniale 180 cm Art. 991/047 Cat. Y
1 Piumotto 230x140 cm 120 gr/m² Art. D63/002 Cat. Must
Double Art. 969/098 Cat. Must
1 Cuscino 50x50 cm mod. B Art. D45/018 Cat. K
1 Cuscino 50x50 cm con cucitura pinzata Art. 969/016 Cat. Must
1 Cuscino 50x50 cm mod. B Art. D82/003 Cat. Must

- 1 Double bed Philip Basso 180x200 cm Bedframe with Valance Legs PIE38V
- 1 Duvet cover set for double bed 180 cm
- 1 Padded throw 230x140 cm 120 gr/m² Double
- 1 Cushion 50x50 cm mod. B
- 1 Cushion 50x50 cm with gathered stitching
- 1 Cushion 50x50 cm mod. B

- 1 Doppelbett Philip Basso 180x200 cm Rahmen mit Volant Fuß PIE38V
- 1 Bettbezug-Set für Doppelbett 180 cm
- 1 Gestepte Tagesdecke 230x140 cm 120 gr/m² Double
- 1 Kissen 50x50 cm Mod. B
- 1 Kissen 50x50 cm mit offener Naht
- 1 Kissen 50x50 cm Mod. B

- 1 Lit Philip Basso double 180x200 cm Cadre avec volant Pieds PIE38V
- 1 Parure housse de couette double 180 cm
- 1 Piumotto 230x140 cm 120 gr/m² Double
- 1 Coussin 50x50 cm mod. B
- 1 Coussin 50x50 cm a/couture francée
- 1 Coussin 50x50 cm mod. B

- 1 Cama Philip Basso 180x200 cm Aro de cama con faldón Pata PIE38V
- 1 Conjunto de funda nórdica 180 cm
- 1 Manta Acolchada 230x140 cm 120 gr/m² Double
- 1 Cojín 50x50 cm mod. B
- 1 Cojín 50x50 cm costura grapada
- 1 Cojín 50x50 cm mod. B

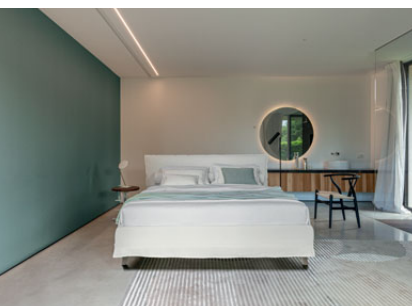

Edo

Pag. 49

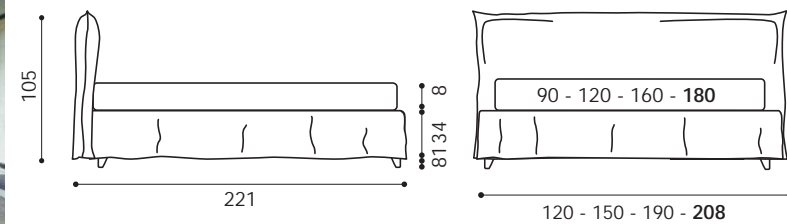

- 1 Letto Edo matrimoniale 180x200 cm Art. A64/001 Cat. Must
Piede PIE68W
- 2 Rollò Soft con cerniera da 90 cm Art. A64/001 Cat. Must
Bordo con cucitura pinzata
- 1 Completo copripiumino matrimoniale 180 cm Art. B66/001 Cat. Z
2 Coprifedera con bordo rivestito Art. D88/001 Cat. Z
1 Copriletto liscio matrimoniale 180 cm Art. D88/001 Cat. Z
2 Cuscini 70x40 cm con cucitura pinzata Art. A64/001 Cat. Must
1 Cuscino 50x30 cm con cucitura pinzata Art. A64/001 Cat. Must
1 Cuscino 50x50 cm con cucitura pinzata Art. A64/024 Cat. Must

- 1 Double bed Edo 180x200 cm Legs PIE68W
- 2 Roll cushion with zip 90 cm with gathered stitching
- 1 Duvet cover set for double bed 180 cm
- 2 Pillow case with piped edge
- 1 Bedspread for double bed 180 cm
- 2 Cushion 70x40 cm with gathered stitching
- 1 Cushion 50x30 cm with gathered stitching
- 1 Cushion 50x50 cm with gathered stitching

- 1 Doppelbett Edo 180x200 cm Fuß PIE68W
- 2 Soft Kissenrolle mit Reißverschluss und offener Naht 90 cm
- 1 Bettbezug-Set für Doppelbett 180 cm
- 2 Kopfkissenbezug mit Keder
- 1 Tagesdecke für Doppelbett 180 cm
- 2 Kissen 70x40 cm mit offener Naht
- 1 Kissen 50x30 cm mit offener Naht
- 1 Kissen 50x50 cm mit offener Naht

- 1 Lit Edo double 180x200 cm Pieds PIE68W
- 2 Rollò soft avec charnière et couture francée 90 cm
- 1 Parure housse de couette double 180 cm
- 2 Housse de taie avec bord revêtu
- 1 Dessus de lit lisse double 180 cm
- 2 Coussin 70x40 cm a/couture francée
- 1 Coussin 50x30 cm a/couture francée
- 1 Coussin 50x50 cm a/couture francée

- 1 Cama Edo 180x200 cm Pata PIE68W
- 2 Cojín cilíndrico soft con cremallera y costura grapada 90 cm
- 1 Conjunto de funda nórdica para cama doble 180 cm
- 2 Funda de almohada con borde revestido
- 1 Cubrecama para cama doble 180 cm
- 2 Cojín 70x40 cm costura grapada
- 1 Cojín 50x30 cm costura grapada
- 1 Cojín 50x50 cm costura grapada



Ekeko Plus h.28 Box

Pag. 59

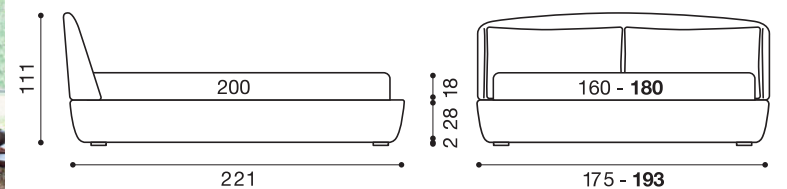

- 1 Letto Ekeko Plus matrimoniale 180x200 cm Art. D90/001 Cat. Must
Giroletto h. 28 Box
Piede PIE16W
- 1 Completo copripiumino matrimoniale 180 cm Art. B66/016 Cat. Z
1 Piumotto 230x140 cm 120 gr/m² Art. C10/008 Cat. K
1 Cuscino 70x40 cm mod. B Art. 969/070 Cat. Must
1 Cuscino 60x60 cm mod. B Art. D83/014 Cat. K
1 Cuscino 70x40 cm mod. B Art. D87/001 Cat. K

- 1 Double bed Ekeko Plus 180x200 cm Bedframe h. 28 Box Legs PIE16W
- 1 Duvet cover set for double bed 180 cm
- 1 Padded throw 230x140 cm 120 gr/m²
- 1 Cushion 70x40 cm mod. B
- 1 Cushion 60x60 cm mod. B
- 1 Cushion 70x40 cm mod. B

- 1 Doppelbett Ekeko Plus 180x200 cm Rahmen h. 28 Box Fuß PIE16W
- 1 Bettbezug-Set für Doppelbett 180 cm
- 1 Gestepte Tagesdecke 230x140 cm 120 gr/m²
- 1 Kissen 70x40 cm Mod. B
- 1 Kissen 60x60 cm Mod. B
- 1 Kissen 70x40 cm Mod. B

- 1 Lit Ekeko Plus double 180x200 cm Cadre h. 28 Box Pieds PIE16W
- 1 Parure housse de couette double 180 cm
- 1 Couette 230x140 cm 120 gr/m²
- 1 Coussin 70x40 cm mod. B
- 1 Coussin 60x60 cm mod. B
- 1 Coussin 70x40 cm mod. B

- 1 Cama Ekeko Plus 180x200 cm Aro de cama h. 28 Box Pata PIE16W
- 1 Conjunto de funda nórdica para cama doble 180 cm
- 1 Manta Acolchada 230x140 cm 120 gr/m²
- 1 Cojín 70x40 cm mod. B
- 1 Cojín 60x60 cm mod. B
- 1 Cojín 70x40 cm mod. B

Variante composizione pag. 59

- 1 Cuscini Testiera Art. D89/001 Cat. K

Composition variation p. 59

- 1 Headboard Cushions

Variation der Zusammensetzung Seite 59

- 1 Kopfteil Kissen

Variation de composition p. 59

- 1 Coussin tête de lit

Variación de composición p. 59

- 1 Cojín de Cabecero



Ekeko Sommier h.28 Box

Pag. 65

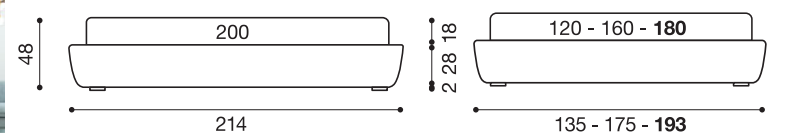

- 1 Letto Ekeko Sommier matrimoniale 180x200 cm Art. D61/015 Cat. K
matrimoniale 180x200 cm
Giroletto h. 28 box
Piede PIE16W
- 2 Rollò con cerniera e bordo rivestito da 90 cm Art. D61/015 Cat. K
Bordo rivestito Art. D61/012 Cat. K
- 1 Completo copripiumino matrimoniale 180 cm Art. 990/042 Cat. Y
- 1 Piumotto 230x140 cm 120 gr/m² Art. 969/070 Cat. Must
- 1 Cuscino 50x30 cm mod. B Art. D78/008 Cat. Must
- 1 Cuscino 60x60 cm mod. B Art. D82/002 Cat. Must
- 1 Cuscino 60x60 cm mod. B Art. D78/008 Cat. Must

- 1 Double bed Ekeko Sommier 180x200 cm Bedframe h. 28 box Legs PIE16W
- 2 Roll cushion with zip and piped edge 90 cm Piped edge
- 1 Duvet cover set for double bed 180 cm
- 1 Padded throw 230x140 cm 120 gr/m²
- 1 Cushion 50x30 cm mod. B
- 1 Cushion 60x60 cm mod. B
- 1 Cushion 60x60 cm mod. B

- 1 Doppelbett Ekeko Sommier 180x200 cm Rahmen h. 28 mit Bettkasten Fuß PIE16W
- 2 Kissenrollen mit Reißverschluss und Keder 90 cm Keder
- 1 Bettbezug-Set für Doppelbett 180 cm
- 1 Gestepte Tagesdecke 230x140 cm 120 gr/m²
- 1 Kissen 50x30 cm Mod. B
- 1 Kissen 60x60 cm Mod. B
- 1 Kissen 60x60 cm Mod. B

- 1 Lit Ekeko Sommier double 180x200 cm Cadre h. 28 box Pieds PIE16W
- 2 Rollò avec charnière et bord revêtu 90 cm Bord revêtu
- 1 Parure housse de couette double 180 cm
- 1 Couette 230x140 cm 120 gr/m²
- 1 Coussin 50x30 cm mod. B
- 1 Coussin 60x60 cm mod. B
- 1 Coussin 60x60 cm mod. B

- 1 Cama Ekeko Sommier 180x200 cm Aro de cama h. 28 box Pata PIE16W
- 2 Cojín cilíndrico con cremallera y borde revestido 90 cm Bordo revestido
- 1 Conjunto de funda nórdica para cama doble 180 cm
- 1 Manta Acolchada 230x140 cm 120 gr/m²
- 1 Cojín 50x30 cm mod. B
- 1 Cojín 60x60 cm mod. B
- 1 Cojín 60x60 cm mod. B



Camaleo con Testiera e Pediera

Pag. 75

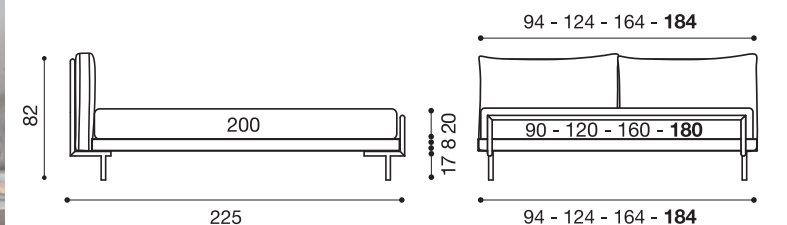

- 1 Letto Camaleo con Testiera e Pediera matrimoniale 180x200 cm Struttura col. 103 Yuta
- 1 Coppia Cuscini Testiera Camaleo 160 Art. B14/005 Cat. Luxury
- 1 Coprirete Camaleo 180x200 cm Art. B14/005 Cat. Luxury
- 1 Completo Lenzuola matrimoniale 180 cm Art. B66/001 Cat. Z
- 1 Copriletto Liscio matrimoniale 180 cm Art. B66/001 Cat. Z
- 1 Copriletto Liscio matrimoniale 180 cm Art. D88/001 Cat. Z
- 2 Coprifedera con bordo rivestito Art. D88/001 Cat. Z
- 1 Cuscino 50x50 cm mod. B Art. C10/017 Cat. K
- 1 Cuscino 50x30 cm mod. B Art. D82/001 Cat. Must

- 1 Double bed Camaleo with Headboard and Footboard 180x200 cm
- 1 Cushions for headboard Camaleo 160
- 1 Bed base cover Camaleo 180x200 cm
- 1 Bed linen set for double bed 180 cm
- 1 Bedspread for double bed 180 cm
- 1 Bedspread for double bed 180 cm
- 2 Pillow case cover with piped edge
- 1 Cushion 50x50 cm mod. B
- 1 Cushion 50x30 cm mod. B

- 1 Doppelbett Camaleo mit Kopfteil und Fussteil 180x200 cm
- 1 Kissen für Kopfteil Camaleo 160
- 1 Lattenrostauflage Camaleo 180x200 cm
- 1 Bettlaken-Set für Doppelbett 180 cm
- 1 Tagesdecke für Doppelbett 180 c
- 1 Tagesdecke für Doppelbett 180 cm
- 2 Kopfkissenbezug mit Keder
- 1 Kissen 50x50 cm Mod. B
- 1 Kissen 50x30 cm Mod. B

- 1 Lit Camaleo avec tête et pied Double 180x200 cm
- 1 Coussins pour la tête de lit Camaleo 160
- 1 Housse du sommier Camaleo 180x200 cm
- 1 Parure drap double 180 cm
- 1 Housse de lit double 180 cm
- 1 Dessus de lit double 180 cm
- 2 Housse de taie avec bord revêtu
- 1 Coussin 50x50 cm mod. B
- 1 Coussin 50x30 cm mod. B

- 1 Cama Camaleo con Cabecero y Pedacero 180x200 cm
- 1 Cojines Cabecero Camaleo 160
- 1 Cubresomier Camaleo 180x200 cm
- 1 Juego de sábanas para cama doble 180 cm
- 1 Cubrecama para cama doble 180 cm
- 1 Cubrecama para cama doble 180 cm
- 2 Funda de almohada con borde revestido
- 1 Cojín 50x50 cm mod. B
- 1 Cojín 50x30 cm mod. B



Ada h. 14
Pag. 83

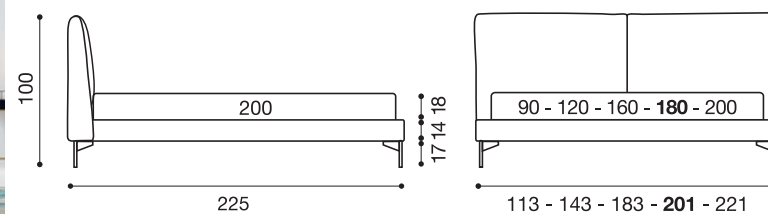

- | | | |
|--|--------------|-----------|
| 1 Letto Ada matrimoniale 180x200 cm
Giroletto h. 14
Piede PIESTD | Art. D78/011 | Cat. Must |
| 1 Completo copripiumino matrimoniale 180 cm | Art. B66/014 | Cat. Z |
| 1 Piumotto 230x140 cm 120 gr/m ² | Art. A64/033 | Cat. Must |
| 1 Cuscino 50x30 cm mod. B | Art. 969/019 | Cat. Must |
| 1 Cuscino 45x45 cm mod. B | Art. C10/010 | Cat. K |
| 1 Cuscino 50x50 cm cucitura pinzata | Art. 969/016 | Cat. Must |
| 1 Cuscino 45x45 cm mod. B | Art. D80/005 | Cat. Must |
| Bordo rivestito | Art. 969/098 | Cat. Must |

- | | | |
|--|--|--|
| 1 Double bed Ada 180x200 cm
Bedframe h. 14
Legs PIESTD | | |
| 1 Duvet cover set for double bed 180 cm | | |
| 1 Padded throw 230x140 cm 120 gr/m ² | | |
| 1 Cushion 50x30 cm mod. B | | |
| 1 Cushion 45x45 cm mod. B | | |
| 1 Cushion 50x50 cm gathered stitching | | |
| 1 Cushion 45x45 cm mod. B | | |
| Piped edge | | |

- | | | |
|---|--|--|
| 1 Doppelbett Ada 180x200 cm
Rahmen h. 14
Fuß PIESTD | | |
| 1 Bettbezug-Set für Doppelbett 180 cm | | |
| 1 Gestepte Tagesdecke 230x140 cm 120 gr/m ² | | |
| 1 Kissen 50x30 cm Mod. B | | |
| 1 Kissen 45x45 cm Mod. B | | |
| 1 Kissen 50x50 cm mit offener Naht | | |
| 1 Kissen 45x45 cm Mod. B | | |
| Keder | | |

- | | | |
|--|--|--|
| 1 Lit Ada double 180x200 cm
Cadre h. 14
Pieds PIESTD | | |
| 1 Parure housse de couette double 180 cm | | |
| 1 Couette 230x140 cm 120 gr/m ² | | |
| 1 Coussin 50x30 cm mod. B | | |
| 1 Coussin 45x45 cm mod. B | | |
| 1 Coussin 50x50 cm a/couture francée | | |
| 1 Coussin 45x45 cm mod. B | | |
| Bord revêtu | | |

- | | | |
|---|--|--|
| 1 Cama Ada 180x200 cm
Aro de cama h. 14
Pata PIESTD | | |
| 1 Conjunto de funda nórdica para cama doble 180 cm | | |
| 1 Manta Acolchada 230x140 cm 120 gr/m ² | | |
| 1 Cojín 50x30 cm mod. B | | |
| 1 Cojín 45x45 cm mod. B | | |
| 1 Cojín 50x50 cm costura grapada | | |
| 1 Cojín 45x45 cm mod. B | | |
| Borde revestido | | |



Ada h. 28
Pag. 89

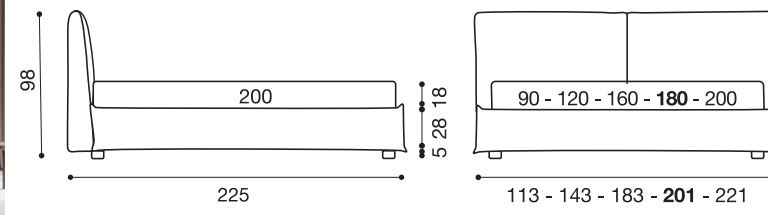

- | | | |
|--|--------------|-----------|
| 1 Letto Ada matrimoniale 180x200 cm
Giroletto h. 28
Piede PIE2PN | Art. A64/028 | Cat. Must |
| 1 Completo copripiumino matrimoniale 180 cm | Art. 991/042 | Cat. Y |
| 1 Piumotto 230x140 cm 120 gr/m ² | Art. A64/028 | Cat. Must |
| 2 Rollo' Soft con cerniera e cucitura pinzata da 90 cm | Art. A64/028 | Cat. Must |
| 1 Cuscino 50x50 cm con cucitura pinzata | Art. 969/016 | Cat. Must |
| 1 Cuscino 50x30 cm mod. B | Art. 969/031 | Cat. Must |
| 1 Cuscino 50x50 cm mod. B | Art. D81/003 | Cat. Must |
| 1 Cuscino 50x50 cm mod. B | Art. D83/004 | Cat. K |

- | | | |
|--|--|--|
| 1 Double bed Ada 180x200 cm
Bedframe h. 28
Legs PIE2PV | | |
| 1 Duvet cover set for double bed 180 cm | | |
| 1 Padded throw 230x140 cm 120 gr/m ² | | |
| 2 Soft roll cushion with zip and gathered stitching 90 cm | | |
| 1 Cushion 50x50 cm with gathered stitching | | |
| 1 Cushion 50x30 cm mod. B | | |
| 1 Cushion 50x50 cm mod. B | | |
| 1 Cushion 50x50 cm mod. B | | |

- | | | |
|---|--|--|
| 1 Doppelbett Ada 180x200 cm
Rahmen h. 28
Fuß PIE2PV | | |
| 1 Bettbezug-Set für Doppelbett 180 cm | | |
| 1 Gestepte Tagesdecke 230x140 cm 120 gr/m ² | | |
| 2 Soft Kissenrollen mit Reißverschluss und offener Naht 90 cm | | |
| 1 Kissen 50x50 cm mit offener Naht | | |
| 1 Kissen 50x30 cm Mod. B | | |
| 1 Kissen 50x50 cm Mod. B | | |
| 1 Kissen 50x50 cm Mod. B | | |

- | | | |
|--|--|--|
| 1 Lit Ada double 180x200 cm
Cadre h. 28
Pieds PIE2PV | | |
| 1 Parure housse de couette double 180 cm | | |
| 1 Couette 230x140 cm 120 gr/m ² | | |
| 2 Rollo' soft avec charnière et a/couture francée 90 cm | | |
| 1 Coussin 50x50 cm a/couture francée | | |
| 1 Coussin 50x30 cm mod. B | | |
| 1 Coussin 50x50 cm mod. B | | |
| 1 Coussin 50x50 cm mod. B | | |

- | | | |
|---|--|--|
| 1 Cama Ada 180x200 cm
Aro de cama h. 28
Pata PIE2PV | | |
| 1 Conjunto de funda nórdica para cama doble 180 cm | | |
| 1 Manta Acolchada 230x140 cm 120 gr/m ² | | |
| 2 Cojín cilíndrico Soft con cremallera y costura grapada da 90 cm | | |
| 1 Cojín 50x50 cm costura grapada | | |
| 1 Cojín 50x30 cm mod. B | | |
| 1 Cojín 50x50 cm mod. B | | |
| 1 Cojín 50x50 cm mod. B | | |



Ada Sommier h. 28
Pag. 95

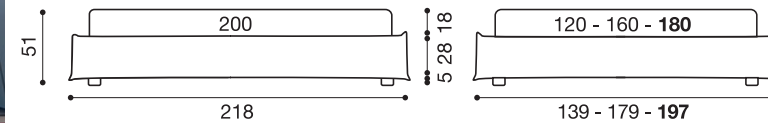

- | | | |
|--|--------------|-----------|
| 1 Letto Ada Sommier matrimoniale 180x200 cm
Giroletto h. 28
Piede PIE2PN | Art. C10/018 | Cat. K |
| 2 Rollo' Soft con cerniera e cucitura pinzata da 90 cm | Art. C10/018 | Cat. K |
| 1 Completo copripiumino matrimoniale 180 cm | Art. B66/011 | Cat. Z |
| 2 Cuscini 70x40 cm con cucitura pinzata | Art. D45/014 | Cat. K |
| 1 Cuscino 70x40 cm mod. B | Art. D82/003 | Cat. Must |

- | | | |
|--|--|--|
| 1 Double bed Ada Sommier 180x200 cm
Bedframe h. 28
Legs PIE2PV | | |
| 2 Soft roll cushion with zip and gathered stitching 90 cm | | |
| 1 Duvet cover set for double bed 180 cm | | |
| 2 Cushions 70x40 cm with gathered stitching | | |
| 1 Cushion 70x40 cm mod. B | | |

- | | | |
|---|--|--|
| 1 Doppelbett Ada Sommier 180x200 cm
Rahmen h. 28
Fuß PIE2PV | | |
| 2 Soft Kissenrollen mit Reißverschluss und offener Naht 90 cm | | |
| 1 Bettbezug-Set für Doppelbett 180 cm | | |
| 2 Kissen 70x40 cm mit offener Naht | | |
| 1 Kissen 70x40 cm Mod. B | | |

- | | | |
|--|--|--|
| 1 Lit Ada Sommier double 180x200 cm
Cadre h. 28
Pieds PIE2PV | | |
| 2 Rollo' soft avec charnière et a/couture francée 90 cm | | |
| 1 Parure housse de couette double 180 cm | | |
| 2 Coussin 70x40 cm a/couture francée | | |
| 1 Coussin 70x40 cm mod. B | | |

- | | | |
|--|--|--|
| 1 Lit Ada Sommier double 180x200 cm
Cadre h. 28
Pieds PIE2PV | | |
| 2 Cojín cilíndrico Soft con cremallera y costura grapada 90 cm | | |
| 1 Conjunto de funda nórdica para cama doble 180 cm | | |
| 2 Cojín 70x40 cm costura grapada | | |
| 1 Cojín 70x40 cm mod. B | | |



Blanca h.28
Pag. 103

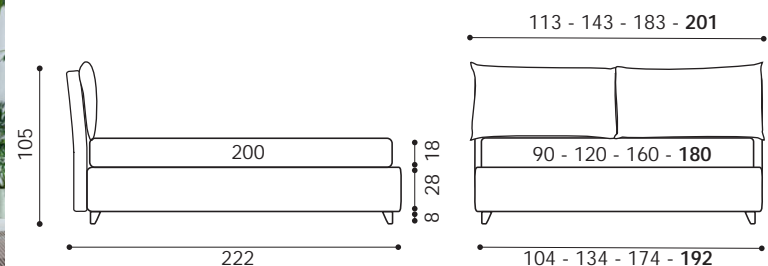

- | | | |
|---|------------------------------|---------------------|
| 1 Letto Blanca matrimoniale 180x200 cm
Bordo Cuscini Testiera
Giroletto h. 28
Piede PIE2DV | Art. D08/005
Art. C28/009 | Cat. K
Cat. Must |
| 1 Completo copripiumino matrimoniale 180 cm | Art. B66/016 | Cat. Z |
| 1 Cuscino 70x40 cm con cucitura pinzata | Art. D60/001 | Cat. K |
| 1 Cuscino 50x50 cm mod. B | Art. D60/001 | Cat. K |
| Bordo rivestito | Art. 969/016 | Cat. Must |
| 1 Cuscino 50x30 cm mod. B | Art. C10/008 | Cat. K |

- | | | |
|--|--|--|
| 1 Double bed Blanca 180x200 cm
Headboard cushions edge
Bedframe h. 28
Legs PIE2DV | | |
| 1 Duvet cover set for double bed 180 cm | | |
| 1 Cushion 70x40 cm with gathered stitching | | |
| 1 Cushion 50x50 cm mod. B | | |
| Piped edge | | |
| 1 Cushion 50x30 cm mod. B | | |

- | | | |
|--|--|--|
| 1 Doppelbett Blanca 180x200 cm
Kopfteil Keder
Rahmen h. 28
Fuß PIE2DV | | |
| 1 Bettbezug-Set für Doppelbett 180 cm | | |
| 1 Kissen 70x40 cm mit offener Naht | | |
| 1 Kissen 50x50 cm Mod. B | | |
| Keder | | |
| 1 Kissen 50x30 cm Mod. B | | |

- | | | |
|--|--|--|
| 1 Lit Blanca double 180x200 cm
Bord revêtu tête de lit
Cadre h. 28
Pieds PIE2DV | | |
| 1 Parure housse de couette double 180 cm | | |
| 1 Coussin 70x40 cm a/couture francée | | |
| 1 Coussin 50x50 cm mod. B | | |
| Bord revêtu | | |
| 1 Coussin 50x30 cm mod. B | | |

- | | | |
|---|--|--|
| 1 Cama Blanca 180x200 cm
Borde Cojín de cabecero
Aro de cama h. 28
Pata PIE2DV | | |
| 1 Conjunto de funda nórdica para cama doble 180 cm | | |
| 1 Cojín 70x40 cm costura grapada | | |
| 1 Cojín 50x50 cm mod. B | | |
| Borde revestido | | |
| 1 Cojín 50x30 cm mod. B | | |

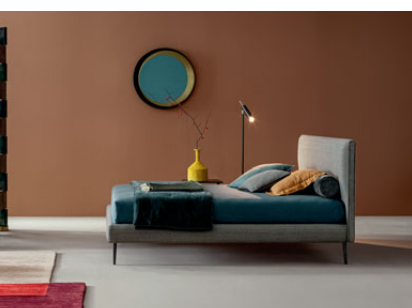

Dread h. 14
Pag. 111

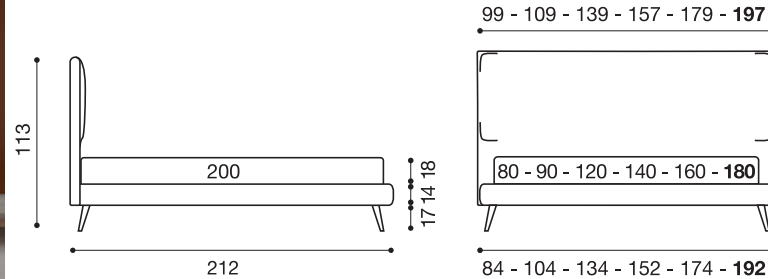

- | | | |
|---|------------------------------|---------------------|
| 1 Letto Dread matrimoniale 180x200 cm
Giroletto h. 25
Bordo rivestito
Piede PIE69Z | Art. D80/005
Art. D56/037 | Cat. Must
Cat. D |
| 1 Completo copripiumino matrimoniale 180 cm | Art. B66/014 | Cat. Z |
| 2 Rollo' con cerniera da 90 cm | Art. C10/023 | Cat. K |
| 1 Piumotto 230x140 cm 120 gr/m ² | Art. D56/037 | Cat. D |
| 1 Plaid William 140x200 cm | Art. 515XGOC150001 | |
| 1 Cuscino 50x30 cm cucitura pinzata | Art. D80/005 | Cat. Must |
| 1 Cuscino 50x50 cm mod. L | Art. D83/005 | Cat. K |
| 1 Cuscino 50x50 cm cucitura pinzata | Art. A64/033 | Cat. Must |
| 1 Cuscino 45x45 cm mod. B | Art. D80/005 | Cat. Must |
| Bordo rivestito | Art. 969/098 | Cat. Must |

- | | | |
|--|--|--|
| 1 Double bed Dread 180x200 cm
Bedframe h. 25
Piped edge
Legs PIE69Z | | |
| 1 Duvet cover set for double bed 180 cm | | |
| 2 Roll cushion with piped edge 90 cm | | |
| 1 Padded throw 230x140 cm 120 gr/m ² | | |
| 1 Plaid William 140x200 cm | | |
| 1 Cushion 50x30 cm gathered stitching | | |
| 1 Cushion 50x50 cm mod. L | | |
| 1 Cushion 50x50 cm gathered stitching | | |
| 1 Cushion 45x45 cm mod. B | | |
| Piped edge | | |

- | | | |
|--|--|--|
| 1 Double bed Dread 180x200 cm
Bedframe h. 25
Piped edge
Legs PIE69Z | | |
| 1 Duvet cover set for double bed 180 cm | | |
| 2 Roll cushion with piped edge 90 cm | | |
| 1 Padded throw 230x140 cm 120 gr/m ² | | |
| 1 Plaid William 140x200 cm | | |
| 1 Cushion 50x30 cm gathered stitching | | |
| 1 Cushion 50x50 cm mod. L | | |
| 1 Cushion 50x50 cm gathered stitching | | |
| 1 Cushion 45x45 cm mod. B | | |
| Piped edge | | |

- | | | |
|---|--|--|
| 1 Lit Dread double 180x200 cm
Aro de cama h. 25
Bord revêtu
Pieds PIE69Z | | |
| 1 Parure housse de couette double 180 cm | | |
| 2 Rollo' avec charnière 90 cm | | |
| 1 Couette 230x140 cm 120 gr/m ² | | |
| 1 Plaid William 140x200 cm | | |
| 1 Coussin 50x30 cm a/couture francée | | |
| 1 Coussin 50x50 cm mod. L | | |
| 1 Coussin 50x50 cm a/couture francée | | |
| 1 Coussin 45x45 cm mod. B | | |
| Bord revêtu | | |

- | | | |
|--|--|--|
| 1 Cama Dread 180x200 cm
Aro de cama h. 25
Borde revestido
Pata PIE69Z | | |
| 1 Conjunto de funda nórdica para cama doble 180 cm | | |
| 2 Cojín cilíndrico con cremallera 90 cm | | |
| 1 Manta Acolchada 230x140 cm 120 gr/m ² | | |
| 1 Plaid William 140x200 cm | | |
| 1 Cojín 50x30 cm costura grapada | | |
| 1 Cojín 50x50 cm mod. L | | |
| 1 Cojín 50x50 cm costura grapada | | |
| 1 Cojín 45x45 cm mod. B | | |
| Borde revestido | | |



Dread h. 25
Pag. 115

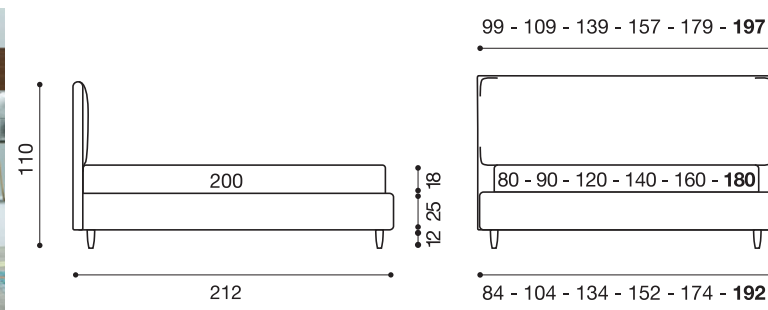

- | | | |
|--|--------------|--------|
| 1 Letto Dread matrimoniale 180x200 cm
Giroletto h. 25
Piede PIE40L | Art. D58/040 | Cat. K |
| 1 Completo copripiumino matrimoniale 180 cm | Art. B66/001 | Cat. Z |
| 1 Piumotto 230x140 cm 120 gr/m ² | Art. D85/001 | Cat. Y |
| 1 Cuscino 50x30 cm mod. B | Art. D75/001 | Cat. K |
| 1 Cuscino 45x45 cm mod. B | Art. C10/010 | Cat. K |
| 1 Cuscino 50x50 cm mod. B | Art. D83/005 | Cat. K |
| 1 Cuscino 70x40 cm con cucitura pinzata | Art. D45/011 | Cat. K |

- | | | |
|--|--|--|
| 1 Double bed Dread 180x200 cm
Bedframe h. 25
Legs PIE40L | | |
| 1 Duvet cover set for double bed 180 cm | | |
| 1 Padded throw 230x140 cm 120 gr/m ² | | |
| 1 Cushion 50x30 cm mod. B | | |
| 1 Cushion 45x45 cm mod. B | | |
| 1 Cushion 50x50 cm mod. B | | |
| 1 Cushion 70x40 cm with gathered stitching | | |

- | | | |
|---|--|--|
| 1 Doppelbett Dread 180x200 cm
Rahmen h. 25
Fuß PIE40L | | |
| 1 Bettbezug-Set für Doppelbett 180 cm | | |
| 1 Gestepte Tagesdecke 230x140 cm 120 gr/m ² | | |
| 1 Kissen 50x30 cm Mod. B | | |
| 1 Kissen 45x45 cm Mod. B | | |
| 1 Kissen 50x50 cm Mod. B | | |
| 1 Kissen 70x40 cm mit offener Naht | | |

- | | | |
|--|--|--|
| 1 Lit Dread double 180x200 cm
Cadre h. 25
Pieds PIE40L | | |
| 1 Parure housse de couette double 180 cm | | |
| 1 Couette 230x140 cm 120 gr/m ² | | |
| 1 Coussin 50x30 cm mod. B | | |
| 1 Coussin 45x45 cm mod. B | | |
| 1 Coussin 50x50 cm mod. B | | |
| 1 Coussin 70x40 cm a/couture francée | | |

- | | | |
|---|--|--|
| 1 Cama Dread 180x200 cm
Aro de cama h. 25
Pata PIE40L | | |
| 1 Conjunto de funda nórdica para cama doble 180 cm | | |
| 1 Manta Acolchada 230x140 cm 120 gr/m ² | | |
| 1 Cojín 50x30 cm mod. B | | |
| 1 Cojín 45x45 cm mod. B | | |
| 1 Cojín 50x50 cm mod. B | | |
| 1 Cojín 70x40 cm costura grapada | | |



Thomas Barrè h. 28
Pag. 121

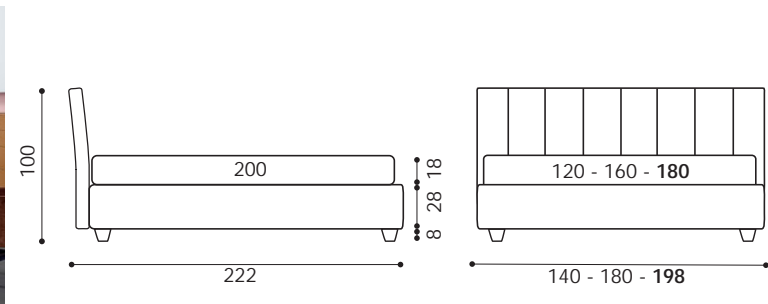

- | | | |
|--|--------------|-----------|
| 1 Letto Thomas Barrè
matrimoniale 180x200 cm
Giroletto h. 28
Piede PIE21V | Art. C10/007 | Cat. K |
| 2 Coprifedera con bordo rivestito | Art. A64/016 | Cat. Must |
| 1 Copriletto liscio matrimoniale 180 cm | Art. A64/016 | Cat. Must |
| 1 Piumotto 230x140 cm 120 gr/m ² | Art. 969/097 | Cat. Must |
| 1 Piumotto 230x140 cm 120 gr/m ² | Art. 969/098 | Cat. Must |
| 1 Cuscino 50x30 cm mod. B | Art. 969/098 | Cat. Must |
| 1 Cuscino 70x40 cm con cucitura pinzata | Art. C10/012 | Cat. K |
| 1 Cuscino 70x40 cm con cucitura pinzata | Art. D87/001 | Cat. K |

- | | | |
|---|--|--|
| 1 Double bed Thomas Barrè 180x200 cm
Bedframe h. 28
Legs PIE21V | | |
| 2 Pillow case with piped edge | | |
| 1 Bedspread for double bed 180 cm | | |
| 1 Padded throw 230x140 cm 120 gr/m ² | | |
| 1 Padded throw 230x140 cm 120 gr/m ² | | |
| 1 Cushion 50x30 cm mod. B | | |
| 1 Cushion 70x40 cm with gathered stitching | | |
| 1 Cushion 70x40 cm with gathered stitching | | |

- | | | |
|--|--|--|
| 1 Doppelbett Thomas Barrè 180x200 cm
Rahmen h. 28
Fuß PIE21V | | |
| 2 Kopfkissenbezug mit Keder | | |
| 1 Tagesdecke für Doppelbett 180 cm | | |
| 1 Gestepte Tagesdecke 230x140 cm 120 gr/m ² | | |
| 1 Gestepte Tagesdecke 230x140 cm 120 gr/m ² | | |
| 1 Kissen 50x30 cm Mod. B | | |
| 1 Kissen 70x40 cm mit offener Naht | | |
| 1 Kissen 70x40 cm mit offener Naht | | |

- | | | |
|---|--|--|
| 1 Lit Thomas Barrè double 180x200 cm
Cadre h. 28
Pieds PIE21V | | |
| 2 Housse de taie avec Bord revêtu | | |
| 1 Dessus de lit lisse double 180 cm | | |
| 1 Couette 230x140 cm 120 gr/m ² | | |
| 1 Couette 230x140 cm 120 gr/m ² | | |
| 1 Coussin 50x30 cm mod. B | | |
| 1 Coussin 70x40 cm a/couture francée | | |
| 1 Coussin 70x40 cm a/couture francée | | |

- | | | |
|--|--|--|
| 1 Cama Thomas Barrè 180x200 cm
Aro de cama h. 28
Pata PIE21V | | |
| 2 Funda de almohada con borde revestido | | |
| 1 Cubrecama para cama doble 180 cm | | |
| 1 Manta Acolchada 230x140 cm 120 gr/m ² | | |
| 1 Manta Acolchada 230x140 cm 120 gr/m ² | | |
| 1 Cojín 50x30 cm mod. B | | |
| 1 Cojín 70x40 cm costura grapada | | |
| 1 Cojín 70x40 cm costura grapada | | |

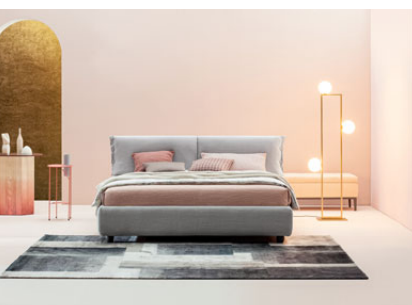

Giselle h. 28
Pag. 129

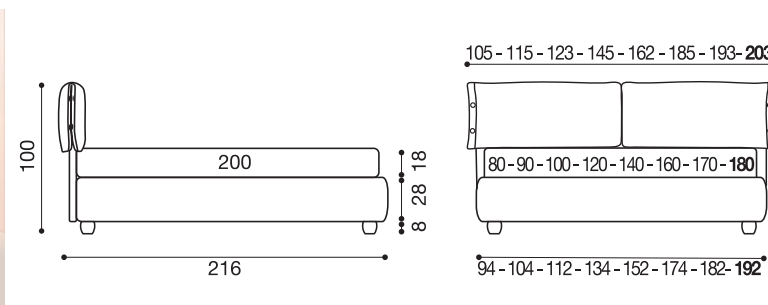

- | | | |
|--|--------------|-----------|
| 1 Letto Giselle matrimoniale 180x200 cm
Giroletto h. 28
Piede PIE20A | Art. A64/037 | Cat. Must |
| 1 Completo lenzuola matrimoniale 180 cm | Art. B66/001 | Cat. Z |
| 2 Coprifedera con bordo rivestito | Art. D86/002 | Cat. Z |
| 1 Piumotto 230x140 cm 120 gr/m ² | Art. D69/002 | Cat. Z |
| 1 Copriletto liscio matrimoniale 180 cm | Art. D86/002 | Cat. Z |
| 1 Copriletto Liscio 260x140 cm | Art. D79/001 | Cat. K |
| 1 Cuscino 50x50 cm mod. B | Art. D83/012 | Cat. K |
| 1 Cuscino 70x40 cm con cucitura pinzata | Art. D81/004 | Cat. Must |
| 1 Cuscino 70x40 cm mod. B | Art. A64/029 | Cat. Must |

- | | | |
|--|--|--|
| 1 Double bed Giselle 180x200 cm
Bedframe h. 28
Legs PIE20A | | |
| 1 Bed linen set for double bed 180 cm | | |
| 2 Pillow case cover with piped edge | | |
| 1 Padded throw 230x140 cm 120 gr/m ² | | |
| 1 Bedspread for double bed 180 cm | | |
| 1 Bedspread plain 260x140 | | |
| 1 Cushion 50x50 cm mod. B | | |
| 1 Cushion 70x40 cm with gathered stitching | | |
| 1 Cushion 70x40 cm mod. B | | |

- | | | |
|---|--|--|
| 1 Doppelbett Giselle 180x200 cm
Rahmen h. 28
Fuß PIE20A | | |
| 1 Bettlaken-Set für Doppelbett 180 cm | | |
| 2 Kopfkissenbezug mit Keder | | |
| 1 Gestepte Tagesdecke 230x140 cm 120 gr/m ² | | |
| 1 Tagesdecke für Doppelbett 180 cm | | |
| 1 Tagesdecke glatt 260x140 cm | | |
| 1 Kissen 50x50 cm Mod. B | | |
| 1 Kissen 70x40 cm mit offener Naht | | |
| 1 Kissen 70x40 cm Mod. B | | |

- | | | |
|--|--|--|
| 1 Lit Giselle double 180x200 cm
Cadre h. 28
Pieds PIE20A | | |
| 1 Parure drap double 180 cm | | |
| 2 Housse de taie avec bord revêtu | | |
| 1 Couette 230x140 cm 120 gr/m ² | | |
| 1 Dessus de lit double 180 cm | | |
| 1 Dessus de lit lisse 260x140 cm | | |
| 1 Coussin 50x50 cm mod. B | | |
| 1 Coussin 70x40 cm a/couture francée | | |
| 1 Coussin 70x40 cm mod. B | | |

- | | | |
|---|--|--|
| 1 Cama Giselle 180x200 cm
Aro de cama h. 28
Pata PIE20A | | |
| 1 Juego de sábanas para cama doble 180 cm | | |
| 2 Funda de almohada con borde revestido | | |
| 1 Manta Acolchada 230x140 cm 120 gr/m ² | | |
| 1 Cubrecama para cama doble 180 cm | | |
| 1 Cubrecama 260x140 cm | | |
| 1 Cojín 50x50 cm mod. B | | |
| 1 Cojín 70x40 cm costura grapada | | |
| 1 Cojín 70x40 cm mod. B | | |



Giselle con gonna
Pag. 133

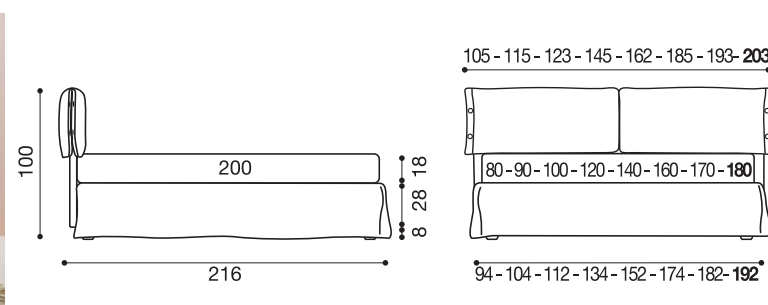

- | | | |
|--|--------------|-----------|
| 1 Letto Giselle matrimoniale 180x200 cm
Giroletto con gonna | Art. A64/037 | Cat. Must |
| 2 Rollo' Soft con cerniera e cucitura pinzata da 90 cm | Art. A64/037 | Cat. Must |
| 1 Completo copripiumino matrimoniale 180 cm | Art. B66/001 | Cat. Z |
| 2 Coprifedera con bordo rivestito | Art. D86/002 | Cat. Z |
| 1 Copriletto liscio matrimoniale 180 cm | Art. D86/002 | Cat. Z |
| 1 Copriletto Liscio 260x140 cm | Art. D79/004 | Cat. K |
| 1 Cuscino 50x30 cm mod. B | Art. 969/035 | Cat. Must |
| 1 Cuscino 50x50 cm mod. L | Art. A64/037 | Cat. Must |
| 1 Cuscino 70x40 cm mod. B | Art. A64/037 | Cat. Must |

- | | | |
|--|--|--|
| 1 Double bed Giselle 180x200 cm
Bedframe with valance | | |
| 2 Roll cushion with zip and gathered stitching da 90 cm | | |
| 1 Duvet cover set for double bed 180 cm | | |
| 2 Pillow case cover with piped edge | | |
| 1 Bedspread for double bed 180 cm | | |
| 1 Bedspread plain 260x140 | | |
| 1 Cushion 50x30 cm mod. B | | |
| 1 Cushion 50x50 cm mod. L | | |
| 1 Cushion 70x40 cm mod. B | | |

- | | | |
|---|--|--|
| 1 Doppelbett Giselle 180x200 cm
Rahmen mit Volant | | |
| 2 Soft Kissenrollen mit Reißverschluss und offener Naht 90 cm | | |
| 1 Bettbezug-Set für Doppelbett 180 cm | | |
| 2 Kopfkissenbezug mit Keder | | |
| 1 Tagesdecke für Doppelbett 180 cm | | |
| 1 Tagesdecke glatt 260x140 cm | | |
| 1 Kissen 50x30 cm Mod. B | | |
| 1 Kissen 50x50 cm Mod. L | | |
| 1 Kissen 70x40 cm Mod. B | | |

- | | | |
|---|--|--|
| 1 Lit Giselle double 180x200 cm
Cadre avec volant | | |
| 2 Rollo' soft avec charnière et a/couture francée 90 cm | | |
| 1 Parure housse de couette double 180 cm | | |
| 2 Housse de taie avec bord revêtu | | |
| 1 Dessus de lit double 180 cm | | |
| 1 Dessus de lit lisse 260x140 cm | | |
| 1 Coussin 50x30 cm mod. B | | |
| 1 Coussin 50x50 cm mod. L | | |
| 1 Coussin 70x40 cm mod. B | | |

- | | | |
|--|--|--|
| 1 Cama Giselle 180x200 cm
Aro de cama h. 28 | | |
| 2 Cojín cilíndrico Soft con cremallera y costura grapada 90 cm | | |
| 1 Conjunto de funda nórdica para cama doble 180 cm | | |
| 2 Funda de almohada con borde revestido | | |
| 1 Cubrecama para cama doble 180 cm | | |
| 1 Cubrecama 260x140 cm | | |
| 1 Cojín 50x30 cm mod. B | | |
| 1 Cojín 50x50 cm mod. L | | |
| 1 Cojín 70x40 cm mod. B | | |



Dorian h.28
Pag. 141

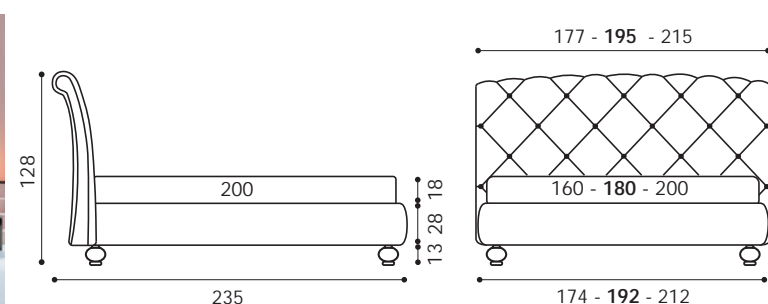

- | | | |
|---|--------------|-------------|
| 1 Letto Dorian matrimoniale 180x200 cm
Giroletto h. 28
Piede PIE48V | Art. 843/008 | Cat. Luxury |
| 2 Rollo' con cerniera e bordo rivestito da 90 cm | Art. 843/008 | Cat. Luxury |
| 1 Completo copripiumino matrimoniale 180 cm | Art. 990/020 | Cat. Y |
| 1 Piumotto 230x140 cm 120 gr/m ² | Art. D61/001 | Cat. K |
| 1 Piumotto 230x140 cm 120 gr/m ² | Art. C10/001 | Cat. K |
| 2 Cuscini 50x50 cm mod. L | Art. D83/002 | Cat. K |

- | | | |
|---|--|--|
| 1 Double bed Dorian 180x200 cm
Bedframe h. 28
Legs PIE48V | | |
| 2 Roll cushion with zip and piping 90 cm | | |
| 1 Duvet cover set for double bed 180 cm | | |
| 1 Padded throw 230x140 cm 120 gr/m ² | | |
| 1 Padded throw 230x140 cm 120 gr/m ² | | |
| 2 Cushion 50x50 cm mod. L | | |

- | | | |
|--|--|--|
| 1 Doppelbett Dorian 180x200 cm
Rahmen h. 28
Fuß PIE48V | | |
| 2 Kissenrolle mit Reißverschluss und Keder 90 cm | | |
| 1 Bettbezug-Set für Doppelbett 180 cm | | |
| 1 Gestepte Tagesdecke 230x140 cm 120 gr/m ² | | |
| 1 Gestepte Tagesdecke 230x140 cm 120 gr/m ² | | |
| 2 Kissen 50x50 cm Mod. L | | |

- | | | |
|---|--|--|
| 1 Lit Dorian double 180x200 cm
Cadre h. 28
Pieds PIE48V | | |
| 2 Rollo' avec charnière et bord revêtu 90 cm | | |
| 1 Parure housse de couette double 180 cm | | |
| 1 Couette 230x140 cm 120 gr/m ² | | |
| 1 Couette 230x140 cm 120 gr/m ² | | |
| 2 Coussin 50x50 cm mod. L | | |

- | | | |
|--|--|--|
| 1 Cama Dorian 180x200 cm
Aro de cama h. 28
Pata PIE48V | | |
| 2 Cojín cilíndrico con cremallera y borde revestido 90 cm | | |
| 1 Conjunto de funda nórdica para cama doble 180 cm | | |
| 1 Manta Acolchada 230x140 cm 120 gr/m ² | | |
| 1 Manta Acolchada 230x140 cm 120 gr/m ² | | |
| 2 Cojín 50x50 cm mod. L | | |



Camille Basso h. 28
Pag. 149

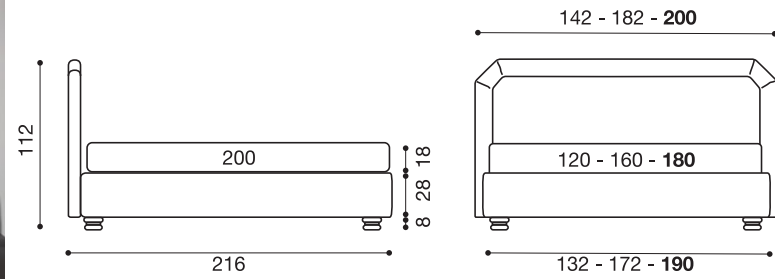

- | | | |
|--|--------------|-----------|
| 1 Letto Camille Basso matrimoniale 180x200 cm
Giroletto h. 28
Piede PIE28V | Art. D61/002 | Cat. K |
| 2 Rollo' con bottone da 90 cm | Art. D61/002 | Cat. K |
| 1 Completo copripiumino matrimoniale 180 cm | Art. D84/001 | Cat. Y |
| 2 Coprifedera con bordo rivestito | Art. D88/002 | Cat. Z |
| 1 Copriletto liscio matrimoniale 180 cm | Art. D88/002 | Cat. Z |
| 1 Copriletto Liscio 260x140 cm | Art. D79/001 | Cat. K |
| 1 Cuscino 50x50 cm | Art. D79/004 | Cat. K |
| 1 Cuscino 50x30 cm mod. B | Art. 969/031 | Cat. Must |

- | | | |
|--|--|--|
| 1 Double bed Camille Basso 180x200 cm
Bedframe h. 28
Legs PIE28V | | |
| 2 Roll cushion with button 90 cm | | |
| 1 Duvet cover set for double bed 180 cm | | |
| 2 Pillow case cover with piped edge | | |
| 1 Bedspread for double bed 180 cm | | |
| 1 Bedspread plain 260x140 | | |
| 1 Cushion 50x50 cm | | |
| 1 Cushion 50x30 cm mod. B | | |

- | | | |
|---|--|--|
| 1 Doppelbett Camille Basso 180x200 cm
Rahmen h. 28
Fuß PIE28V | | |
| 2 Kissenrollen mit Knöpfe 90 cm | | |
| 1 Bettbezug-Set für Doppelbett 180 cm | | |
| 2 Kopfkissenbezug mit Keder | | |
| 1 Tagesdecke für Doppelbett 180 cm | | |
| 1 Tagesdecke glatt 260x140 cm | | |
| 1 Kissen 50x50 cm | | |
| 1 Kissen 50x30 cm Mod. B | | |

- | | | |
|--|--|--|
| 1 Lit Camille Basso double 180x200 cm
Cadre h. 28
Pieds PIE28V | | |
| 2 Rollo' avec boutons 90 cm | | |
| 1 Parure housse de couette double 180 cm | | |
| 2 Housse de taie avec bord revêtu | | |
| 1 Dessus de lit double 180 cm | | |
| 1 Dessus de lit lisse 260x140 cm | | |
| 1 Coussin 50x50 cm | | |
| 1 Coussin 50x30 cm mod. B | | |

- | | | |
|---|--|--|
| 1 Cama Camille Basso 180x200 cm
Aro de cama h. 28
Pata PIE28V | | |
| 2 Cojín cilíndrico con botón 90 cm | | |
| 1 Conjunto de funda nórdica para cama doble 180 cm | | |
| 2 Funda de almohada con borde revestido | | |
| 1 Cubrecama para cama doble 180 cm | | |
| 1 Cubrecama 260x140 cm | | |
| 1 Cojín 50x50 cm | | |
| 1 Cojín 50x30 cm mod. B | | |



Camille Alto Capitoné h. 28
Pag. 157

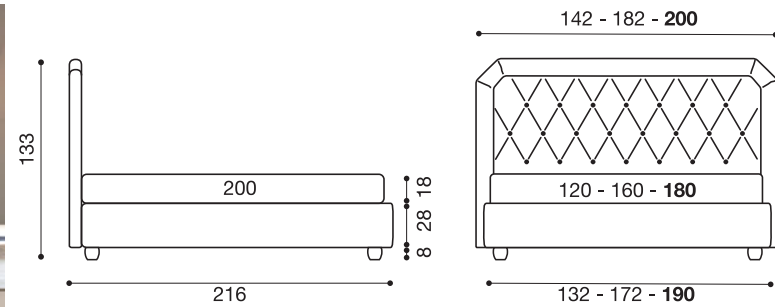

- | | | |
|---|--------------|-------------|
| 1 Letto Camille Alto Capitoné' matrimoniale 180x200 cm
Giroletto h. 28
Piede PIE20V | Art. 843/010 | Cat. Luxury |
| 2 Rollo' con cerniera da 90 cm | Art. 843/010 | Cat. Luxury |
| 1 Completo copripiumino matrimoniale 180 cm | Art. B66/500 | Cat. Z |
| 1 Piumotto 230x140 cm 120 gr/m² Double | Art. 969/031 | Cat. Must |
| 1 Copriletto Liscio 260x140 cm | Art. 969/037 | Cat. Must |
| 1 Copriletto Liscio 260x140 cm | Art. D79/003 | Cat. K |
| 2 Cuscini 50x50 cm mod. B | Art. D75/001 | Cat. K |

- | | | |
|---|--|--|
| 1 Double bed Camille Alto Capitoné' 180x200 cm
Bedframe h. 28
Legs PIE20V | | |
| 2 Roll cushion with zip 90 cm | | |
| 1 Duvet cover set for double bed 180 cm | | |
| 1 Padded throw 230x140 cm 120 gr/m² Double | | |
| 1 Bedspread plain 260x140 | | |
| 2 Cushion 50x50 cm mod. B | | |

- | | | |
|--|--|--|
| 1 Doppelbett Camille Alto Capitoné' 180x200 cm
Rahmen h. 28
Fuß PIE20V | | |
| 2 Kissenrollen mit Reißverschluss 90 cm | | |
| 1 Bettbezug-Set für Doppelbett 180 cm | | |
| 1 Gestepte Tagesdecke 230x140 cm 120 gr/m² Double | | |
| 1 Tagesdecke glatt 260x140 cm | | |
| 2 Kissen 50x50 cm Mod. B | | |

- | | | |
|---|--|--|
| 1 Lit Camille Alto Capitoné' double 180x200 cm
Cadre h. 28
Pieds PIE20V | | |
| 2 Rollo' avec charnière 90 cm | | |
| 1 Parure housse de couette double 180 cm | | |
| 1 Couette 230x140 cm 120 gr/m² Double | | |
| 1 Dessus de lit lisse 260x140 cm | | |
| 2 Coussin 50x50 cm mod. B | | |

- | | | |
|--|--|--|
| 1 Cama Camille Alto Capitoné' 180x200 cm
Aro de cama h. 28
Pata PIE20V | | |
| 2 Cojín cilíndrico 90 cm | | |
| 1 Conjunto de funda nórdica para cama doble 180 cm | | |
| 1 Manta Acolchada 230x140 cm 120 gr/m² Double | | |
| 1 Cubrecama 260x140 cm | | |
| 2 Cojín 50x50 cm mod. B | | |



Soul h. 28
Pag. 163

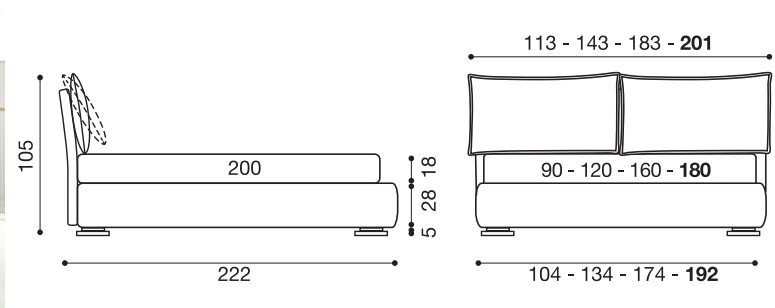

- | | | |
|---|--------------|-----------|
| 1 Letto Soul matrimoniale 180x200 cm
Giroletto h. 28
Piede PIE26I | Art. D57/004 | Cat. Must |
| 1 Completo copripiumino matrimoniale 180 cm | Art. B66/012 | Cat. Z |
| 1 Cuscino 45x45 cm mod. B | Art. D80/005 | Cat. Must |
| Bordo rivestito | Art. 969/098 | Cat. Must |
| 1 Cuscino 50x50 cm con cucitura pinzata | Art. A64/015 | Cat. Must |
| 1 Cuscino 50x50 cm mod. B | Art. 969/031 | Cat. Must |
| 1 Cuscino 70x40 cm mod. B | Art. D60/001 | Cat. K |
| Bordo rivestito | Art. 969/016 | Cat. Must |

- | | | |
|---|--|--|
| 1 Double bed Soul 180x200 cm
Bedframe h. 28
Legs PIE26I | | |
| 1 Duvet cover set for double bed 180 cm | | |
| 1 Cushion 45x45 cm mod. B | | |
| Piped edge | | |
| 1 Cushion 50x50 cm with gathered stitching | | |
| 1 Cushion 50x50 cm mod. B | | |
| 1 Cushion 70x40 cm mod. B | | |
| Piped edge | | |

- | | | |
|--|--|--|
| 1 Doppelbett Soul 180x200 cm
Rahmen h. 28
Fuß PIE26I | | |
| 1 Bettbezug-Set für Doppelbett 180 cm | | |
| 1 Kissen 45x45 cm Mod. B | | |
| Keder | | |
| 1 Kissen 50x50 cm mit offener Naht | | |
| 1 Kissen 50x50 cm mod. B | | |
| 1 Kissen 70x40 cm Mod. B | | |
| Keder | | |

- | | | |
|---|--|--|
| 1 Lit Soul double 180x200 cm
Cadre h. 28
Pieds PIE26I | | |
| 1 Parure housse de couette double 180 cm | | |
| 1 Coussin 45x45 cm mod. B | | |
| Bord revêtu | | |
| 1 Coussin 50x50 cm a/couture francée | | |
| 1 Coussin 50x50 cm mod. B | | |
| 1 Coussin 70x40 cm mod. B | | |
| Bord revêtu | | |

- | | | |
|--|--|--|
| 1 Cama Soul 180x200 cm
Aro de cama h. 28
Pata PIE26I | | |
| 1 Conjunto de funda nórdica para cama doble 180 cm | | |
| 1 Cojín 45x45 cm mod. B | | |
| Borde revestido | | |
| 1 Cojín 50x50 cm costura grapada | | |
| 1 Cojín 50x50 cm mod. B | | |
| 1 Cojín 70x40 cm mod. B | | |
| Borde revestido | | |

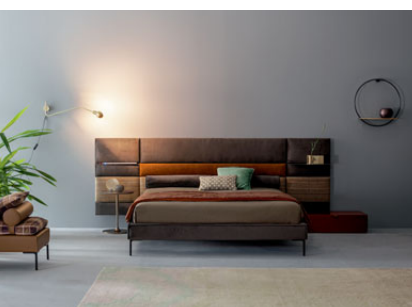

Ada Sommier 3Lati h. 14
Pag. 171

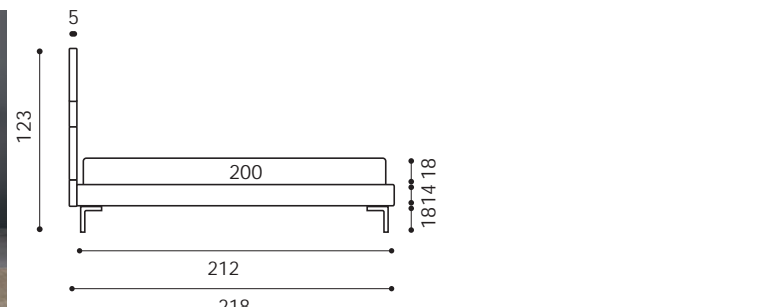

- | | | |
|--|----------------|-------------|
| 1 Letto Ada Sommier 3Lati matrimoniale 180x200 cm
Giroletto h. 14
Piede PIE61Z | Art. 969/028 | Cat. Must |
| 2 Rollo' Soft con cerniera da 90 cm | Art. 969/028 | Cat. Must |
| 1 Completo copripiumino matrimoniale 180 cm | Art. C87/004 | Cat. Y |
| 1 Piumotto 230x140 cm 120 gr/m² Double | Art. 969/031 | Cat. Must |
| 1 Cuscino 50x30 cm mod. B | Art. 969/037 | Cat. Must |
| Bordo rivestito | Art. D81/003 | Cat. Must |
| 1 Cuscino 50x50 cm con cucitura pinzata | Art. D80/003 | Cat. Must |
| 1 Pannello Boiserie Set Slim 200x17 cm | Art. B97/009 | Cat. C |
| 4 Pannelli Boiserie Set Slim 60x17 cm | Art. 969/028 | Cat. Must |
| 2 Pannelli Boiserie Set Slim 60x35 cm | Art. 969/028 | Cat. Must |
| 1 Pannello Boiserie Set Slim 200x35 cm | Art. 969/028 | Cat. Must |
| 1 Pannello Boiserie Set Slim 200x17 cm | Art. 843/005 | Cat. Luxury |
| 2 Pannelli Boiserie Set Slim 60x35 cm | Art. D80/007 | Cat. Must |
| 1 Pannello Boiserie Set Slim 200x35 cm | Art. D80/007 | Cat. Must |
| 1 Mensola Set | Art. 27N060035 | |
| 1 Lampada Led | Art. 31QTLM | |

- | | | |
|---|--|--|
| 1 Double bed Sommier Ada 3Sides 180x200 cm
Bedframe h. 14
Legs PIE61Z | | |
| 2 Soft roll cushion with zip 90 cm | | |
| 1 Duvet cover set for double bed 180 cm | | |
| 1 Padded throw 230x140 cm 120 gr/m² Double | | |
| 1 Cushion 50x30 cm mod. B | | |
| Piped edge | | |
| 1 Cushion 50x50 cm with gathered stitching | | |
| 1 Boiserie Set Slim panel 200x17 cm | | |
| 4 Boiserie Set Slim panels 60x17 cm | | |
| 2 Boiserie Set Slim panels 60x35 cm | | |
| 1 Boiserie Set Slim panel 200x35 cm | | |
| 1 Boiserie Set Slim panel 200x17 cm | | |
| 2 Boiserie Set Slim panels 60x35 cm | | |
| 1 Boiserie Set Slim panel 200x35 cm | | |
| 1 Set shelf | | |
| 1 Led lamp | | |

- | | | |
|--|--|--|
| 1 Ada Sommier 3Seiten 180x200 cm
Rahmen h. 14
Fuß PIE61Z | | |
| 2 Soft Kissenrolle mit Reißverschluss 90 cm | | |
| 1 Bettbezug-Set für Doppelbett 180 cm | | |
| 1 Gestepte Tagesdecke 230x140 cm 120 gr/m² Double | | |
| 1 Kissen 50x30 cm Mod. B | | |
| Keder | | |
| 1 Kissen 50x50 cm mit offener Naht | | |
| 1 Wandpaneel Boiserie Set Slim 200x17 cm | | |
| 4 Wandpaneel Boiserie Set Slim 60x17 cm | | |
| 2 Wandpaneel Boiserie Set Slim 60x35 cm | | |
| 1 Wandpaneel Boiserie Set Slim 200x35 cm | | |
| 1 Wandpaneel Boiserie Set Slim 200x17 cm | | |
| 2 Wandpaneel Boiserie Set Slim 60x35 cm | | |
| 1 Wandpaneel Boiserie Set Slim 200x35 cm | | |
| 1 Ablage Set | | |
| 1 Led Beleuchtung | | |

- | | | |
|--|--|--|
| 1 Lit Sommier Ada 3Lati double 180x200 cm
Cadre h. 14
Pieds PIE61Z | | |
| 2 Rollo' Soft avec charnière 90 cm | | |
| 1 Parure housse de couette double 180 cm | | |
| 1 Couette 230x140 cm 120 gr/m² Double | | |
| 1 Coussin 50x30 cm mod. B | | |
| Bord revêtu | | |
| 1 Coussin 50x50 cm a/couture francée | | |
| 1 Panneaux Boiserie Set Slim 200x17 cm | | |
| 4 Panneaux Boiserie Set Slim 60x17 cm | | |
| 2 Panneaux Boiserie Set Slim 60x35 cm | | |
| 1 Panneaux Boiserie Set Slim 200x35 cm | | |
| 1 Panneaux Boiserie Set Slim 200x17 cm | | |
| 2 Panneaux Boiserie Set Slim 60x35 cm | | |
| 1 Panneaux Boiserie Set Slim 200x35 cm | | |
| 1 Étagère Set | | |
| 1 Lumière Led | | |

- | | | |
|--|--|--|
| 1 Cama Sommier Ada 3Lados 180x200 cm
Aro de cama h. 14
Pata PIE61Z | | |
| 2 Cojín cilíndrico Soft con cremallera 90 cm | | |
| 1 Conjunto de funda nórdica para cama doble 180 cm | | |
| 1 Manta Acolchada 230x140 cm 120 gr/m² Double | | |
| 1 Cojín 50x30 cm mod. B | | |
| Borde revestido | | |
| 1 Cojín 50x50 cm con costura grapada | | |
| 1 Panel Boiserie Set Slim 200x17 cm | | |
| 4 Paneles Boiserie Set Slim 60x17 cm | | |
| 2 Paneles Boiserie Set Slim 60x35 cm | | |
| 1 Panel Boiserie Set Slim 200x35 cm | | |
| 1 Panel Boiserie Set Slim 200x17 cm | | |
| 2 Paneles Boiserie Set Slim 60x35 cm | | |
| 1 Panel Boiserie Set Slim 200x35 cm | | |
| 1 Repisa Set | | |
| 1 Lampara Led | | |

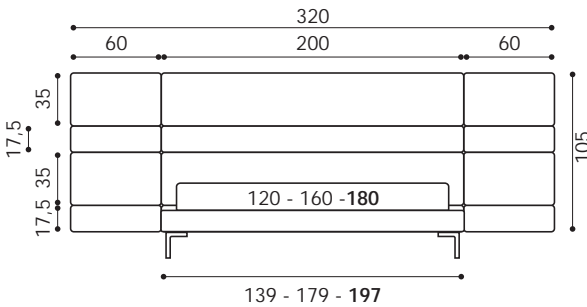

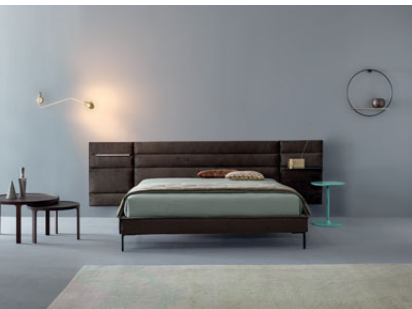

Ada Sommier 3Lati h. 14
Pag. 177

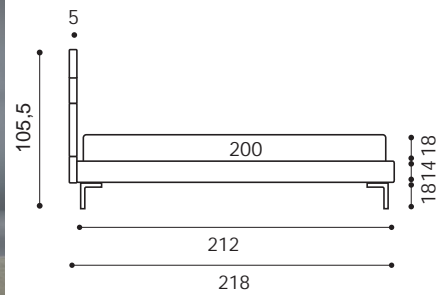

- | | | |
|--|----------------|-----------|
| 1 Letto Ada Sommier
3 Lati matrimoniale 180x200 cm
Giroletto h. 14
Piede PIE61Z | Art. 969/028 | Cat. Must |
| 1 Completo copripiumino matrimoniale 180 cm | Art. 991/047 | Cat. Y |
| 1 Piumotto 230x140 cm 120 gr/m ² | Art. 969/097 | Cat. Must |
| 1 Cuscino 50x30 cm mod. B | Art. D81/003 | Cat. Must |
| 1 Bordo rivestito | Art. D80/003 | Cat. Must |
| 1 Cuscino 70x40 cm con cucitura pinzata | Art. C10/012 | Cat. K |
| 3 Pannelli Boiserie Set Slim 200x17 cm | Art. 969/028 | Cat. Must |
| 6 Pannelli Boiserie Set Slim 60x17 cm | Art. 969/028 | Cat. Must |
| 2 Pannelli Boiserie Set Slim 60x35 cm | Art. 969/028 | Cat. Must |
| 1 Pannello Boiserie Set Slim 200x35 cm | Art. 969/028 | Cat. Must |
| 1 Mensola Set | Art. 27N060035 | |
| 1 Lampada Led | Art. 31QTLM | |

- | | | |
|--|--|--|
| 1 Double bed Sommier Ada
3Sides 180x200 cm
Bedframe h. 14
Legs PIE61Z | | |
| 1 Duvet cover set for double bed 180 cm | | |
| 1 Padded throw 230x140 cm 120 gr/m ² | | |
| 1 Cushion 50x30 cm mod. B | | |
| 1 Piped edge | | |
| 1 Cushion 70x40 cm with gathered stitching | | |
| 3 Boiserie Set Slim panels 200x17 cm | | |
| 6 Boiserie Set Slim panels 60x17 cm | | |
| 2 Boiserie Set Slim panels 60x35 cm | | |
| 1 Boiserie Set Slim panel 200x35 cm | | |
| 1 Set shelf | | |
| 1 Led lamp | | |

- | | | |
|---|--|--|
| 1 Ada Sommier
3Seiten 180x200 cm
Rahmen h. 14
Fuß PIE61Z | | |
| 1 Bettbezug-Set für Doppelbett 180 cm | | |
| 1 Gestepte Tagesdecke 230x140 cm 120 gr/m ² | | |
| 1 Kissen 50x30 cm Mod. B | | |
| 1 Keder | | |
| 1 Kissen 70x40 cm mit offener Naht | | |
| 3 Wandpaneele Boiserie Set Slim 200x17 cm | | |
| 6 Wandpaneele Boiserie Set Slim 60x17 cm | | |
| 2 Wandpaneele Boiserie Set Slim 60x35 cm | | |
| 1 Wandpaneele Boiserie Set Slim 200x35 cm | | |
| 1 Ablage Set | | |
| 1 Led Beleuchtung | | |

- | | | |
|---|--|--|
| 1 Lit Sommier Ada
3Lati double 180x200 cm
Cadre h. 14
Pieds PIE61Z | | |
| 1 Parure housse de couette double 180 cm | | |
| 1 Couette 230x140 cm 120 gr/m ² | | |
| 1 Coussin 50x30 cm mod. B | | |
| 1 Bord revêtu | | |
| 1 Coussin 70x40 cm a/couture francée | | |
| 3 Panneaux Boiserie Set Slim 200x17 cm | | |
| 6 Panneaux Boiserie Set Slim 60x17 cm | | |
| 2 Panneaux Boiserie Set Slim 60x35 cm | | |
| 1 Panneaux Boiserie Set Slim 200x35 cm | | |
| 1 Étagère Set | | |
| 1 Lumière Led | | |

- | | | |
|---|--|--|
| 1 Cama Sommier
Ada 3Lados 180x200 cm
Aro de cama h. 14
Pata PIE61Z | | |
| 1 Conjunto de funda nórdica para cama doble 180 cm | | |
| 1 Manta Acolchada 230x140 cm 120 gr/m ² | | |
| 1 Cojín 50x30 cm mod. B | | |
| 1 Borde revestido | | |
| 1 Cojín 70x40 cm con costura grapada | | |
| 3 Paneles Boiserie Set Slim 200x17 cm | | |
| 6 Paneles Boiserie Set Slim 60x17 cm | | |
| 2 Paneles Boiserie Set Slim 60x35 cm | | |
| 1 Panel Boiserie Set Slim 200x35 cm | | |
| 1 Repisa Set | | |
| 1 Lampara Led | | |

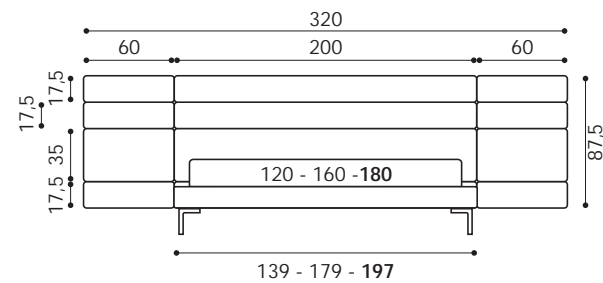

- | | | |
|--|--------------|-----------|
| 1 Letto Frick Basso matrimoniale 180x200 cm
Giroletto h. 25
Pannello con bordo rivestito
Piede PIE3CH | Art. C40/002 | Cat. Must |
| 1 Completo copripiumino matrimoniale 180 cm | Art. 991/032 | Cat. Y |
| 1 Piumotto 230x140 cm 120 gr/m ² | Art. C10/023 | Cat. K |
| 1 Cuscino 50x30 cm mod. B | Art. D81/005 | Cat. Must |
| 1 Cuscino 50x30 cm mod. B | Art. 969/098 | Cat. Must |
| 1 Cuscino 50x50 cm mod. B | Art. D82/001 | Cat. Must |

- | | | |
|---|--|--|
| 1 Double bed Frick Basso 180x200 cm
Bedframe h. 25
Panel with piped edge
Legs PIE3CH | | |
| 1 Duvet cover set for double bed 180 cm | | |
| 1 Padded throw 230x140 cm 120 gr/m ² | | |
| 1 Cushion 50x30 cm mod. B | | |
| 1 Cushion 50x30 cm mod. B | | |
| 1 Cushion 50x50 cm mod. B | | |

- | | | |
|---|--|--|
| 1 Doppelbett Frick Basso 180x200 cm
Rahmen h. 25
Kopfteil mit Keder
Fuß PIE3CH | | |
| 1 Bettbezug-Set für Doppelbett 180 cm | | |
| 1 Gestepte Tagesdecke 230x140 cm 120 gr/m ² | | |
| 1 Kissen 50x30 cm Mod. B | | |
| 1 Kissen 50x30 cm Mod. B | | |
| 1 Kissen 50x50 cm Mod. B | | |

- | | | |
|---|--|--|
| 1 Doppelbett Frick Basso 180x200 cm
Rahmen h. 25
Kopfteil mit Keder
Fuß PIE3CH | | |
| 1 Bettbezug-Set für Doppelbett 180 cm | | |
| 1 Gestepte Tagesdecke 230x140 cm 120 gr/m ² | | |
| 1 Kissen 50x30 cm Mod. B | | |
| 1 Kissen 50x30 cm Mod. B | | |
| 1 Kissen 50x50 cm Mod. B | | |

- | | | |
|--|--|--|
| 1 Cama Frick Basso 180x200 cm
Aro de cama h. 25
Panel con Borde revestido
Pata PIE3CH | | |
| 1 Conjunto de funda nórdica para cama doble 180 cm | | |
| 1 Manta Acolchada 230x140 cm 120 gr/m ² | | |
| 1 Cojín 50x30 cm mod. B | | |
| 1 Cojín 50x30 cm mod. B | | |
| 1 Cojín 50x50 cm mod. B | | |



Frick Basso h. 25
Pag. 183

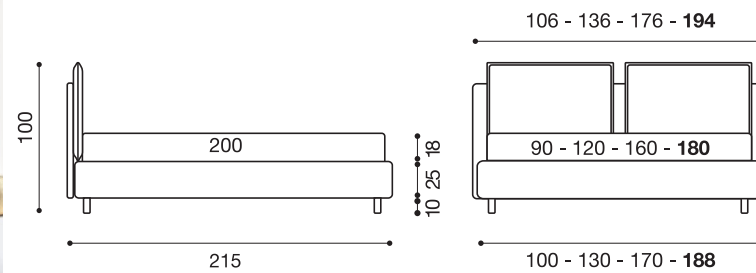

Frick Round h. 25
Pag. 187

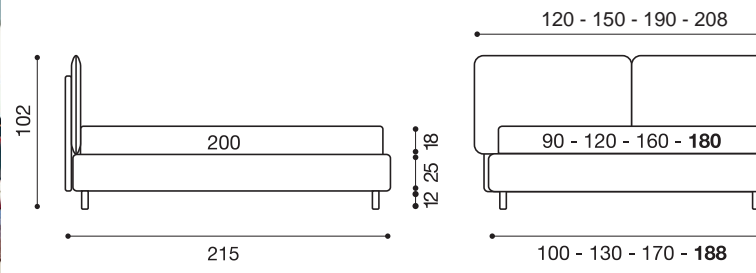

- | | | |
|---|--------------------|-----------|
| 1 Letto Frick Round matrimoniale 180x200 cm
Giroletto h. 25
Pannello con bordo rivestito
Bordo rivestito
Piede PIE4CV | Art. 969/031 | Cat. Must |
| 1 Completo copripiumino matrimoniale 180 cm | Art. C87/004 | Cat. Z |
| 1 Piumotto 230x140 cm 120 gr/m ² | Art. 969/031 | Cat. Must |
| 1 Double | Art. 969/037 | Cat. Must |
| 1 Plaid William 140x200 cm | Art. 515XGOC150003 | |
| 1 Cuscino 45x45 cm con cucitura pinzata | Art. C10/012 | Cat. K |
| 1 Cuscino 50x50 cm mod. B | Art. D83/005 | Cat. K |
| 1 Cuscino 50x50 cm mod. B | Art. D81/003 | Cat. Must |
| 1 Cuscino 70x40 cm mod. B | Art. C10/007 | Cat. K |

- | | | |
|---|--|--|
| 1 Double bed Frick Round 180x200 cm
Bedframe h. 25
Panel with piped edge
Piped edge
Legs PIE4CV | | |
| 1 Duvet cover set for double bed 180 cm | | |
| 1 Padded throw 230x140 cm 120 gr/m ² | | |
| 1 Double | | |
| 1 Plaid William 140x200 cm | | |
| 1 Cushion 45x45 cm with gathered stitching | | |
| 1 Cushion 50x50 cm mod. B | | |
| 1 Cushion 50x50 cm mod. B | | |
| 1 Cushion 70x40 cm mod. B | | |

- | | | |
|--|--|--|
| 1 Doppelbett Frick Round 180x200 cm
Rahmen h. 25
Kopfteil mit Keder
Keder
Fuß PIE4CV | | |
| 1 Bettbezug-Set für Doppelbett 180 cm | | |
| 1 Gestepte Tagesdecke 230x140 cm 120 gr/m ² | | |
| 1 Double | | |
| 1 Plaid William 140x200 cm | | |
| 1 Kissen 45x45 cm mit offener Naht | | |
| 1 Kissen 50x50 cm Mod. B | | |
| 1 Kissen 50x50 cm Mod. B | | |
| 1 Kissen 70x40 cm Mod. B | | |

- | | | |
|--|--|--|
| 1 Lit Frick Round double 180x200 cm
Cadre h. 25
Panneaux avec bord revêtu
Bord revêtu
Pieds PIE4CV | | |
| 1 Parure housse de couette double 180 cm | | |
| 1 Couette 230x140 cm 120 gr/m ² | | |
| 1 Double | | |
| 1 Plaid William 140x200 cm | | |
| 1 Coussin 45x45 cm a/couture francée | | |
| 1 Coussin 50x50 cm mod. B | | |
| 1 Coussin 50x50 cm mod. B | | |
| 1 Coussin 70x40 cm mod. B | | |

- | | | |
|--|--|--|
| 1 Cama Frick Round 180x200 cm
Aro de cama h. 25
Pannel con borde revestido
Borde revestido
Pata PIE4CV | | |
| 1 Conjunto de funda nórdica para cama doble 180 cm | | |
| 1 Manta Acolchada 230x140 cm 120 gr/m ² | | |
| 1 Double | | |
| 1 Plaid William 140x200 cm | | |
| 1 Cojín 45x45 cm costura grapada | | |
| 1 Cojín 50x50 cm mod. B | | |
| 1 Cojín 50x50 cm mod. B | | |
| 1 Cojín 70x40 cm mod. B | | |

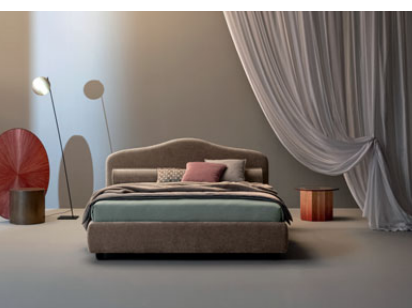

Medea h. 28
Pag. 195

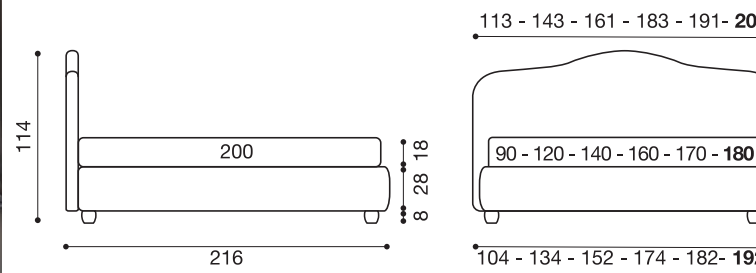

- | | | |
|--|--------------|-----------|
| 1 Letto Medea matrimoniale 180x200 cm
Giroletto h. 28
Piede PIE20V | Art. C10/009 | Cat. K |
| 2 Rollo' con cerniera da 90 cm | Art. C10/009 | Cat. K |
| 1 Completo copripiumino matrimoniale 180 cm | Art. 991/047 | Cat. Y |
| 1 Piumotto 230x140 cm 120 gr/m ² | Art. 969/033 | Cat. Must |
| 1 Copriletto Liscio 260x140 cm | Art. D79/004 | Cat. K |
| 1 Cuscino 50x30 cm mod. B | Art. D81/003 | Cat. Must |
| 1 Bordo rivestito | Art. D80/007 | Cat. Must |
| 1 Cuscino 50x50 cm con cucitura pinzata | Art. D80/003 | Cat. Must |
| 1 Cuscino 50x50 cm mod. B | Art. 969/035 | Cat. Must |

- | | | |
|--|--|--|
| 1 Double bed Medea 180x200 cm
Bedframe h. 28
Legs PIE20V | | |
| 2 Roll cushion with zip 90 cm | | |
| 1 Duvet cover set for double bed 180 cm | | |
| 1 Padded throw 230x140 cm 120 gr/m ² | | |
| 1 Bedspread plain 260x140 | | |
| 1 Cushion 50x30 cm mod. B | | |
| 1 Piped edge | | |
| 1 Cushion 50x50 cm with gathered stitching | | |
| 1 Cushion 50x50 cm mod. B | | |

- | | | |
|---|--|--|
| 1 Doppelbett Medea 180x200 cm
Rahmen h. 28
Pieds PIE20V | | |
| 2 Kissenrollen mit Reißverschluss 90 cm | | |
| 1 Bettbezug-Set für Doppelbett 180 cm | | |
| 1 Gestepte Tagesdecke 230x140 cm 120 gr/m ² | | |
| 1 Tagesdecke glatt 260x140 cm | | |
| 1 Kissen 50x30 cm Mod. B | | |
| 1 Keder | | |
| 1 Kissen 50x50 cm mit offener Naht | | |
| 1 Kissen 50x50 cm Mod. B | | |

- | | | |
|---|--|--|
| 1 Lit Medea double 180x200 cm
Rahmen h. 28
Pieds PIE20V | | |
| 2 Rollo' avec charnière 90 cm | | |
| 1 Parure housse de couette double 180 cm | | |
| 1 Couette 230x140 cm 120 gr/m ² | | |
| 1 Dessus de lit lisse 260x140 cm | | |
| 1 Coussin 50x30 cm mod. B | | |
| 1 Bord revêtu | | |
| 1 Coussin 50x50 cm a/couture francée | | |
| 1 Coussin 50x50 cm mod. B | | |

- | | | |
|---|--|--|
| 1 Cama Medea 180x200 cm
Aro de cama h. 28
Pata PIE20V | | |
| 2 Cojín cilíndrico 90 cm | | |
| 1 Conjunto de funda nórdica para cama doble 180 cm | | |
| 1 Manta Acolchada 230x140 cm 120 gr/m ² | | |
| 1 Cubrecama 260x140 cm | | |
| 1 Cojín 50x30 cm mod. B | | |
| 1 Borde revestido | | |
| 1 Cojín 50x50 cm costura grapada | | |
| 1 Cojín 50x50 cm mod. B | | |

Credits

Art direction & graphic:

Silvia Prevedello Studio

~

Photography:

Paolo Golumelli

Niamh Malone (model_photographer)

~

Styling:

Cristina Chinellato

~

Photolitho & Print:

Grafiche Antiga

~

Thanks to:

Mingardo

Tooy

Sahrai

Nodus rug

Edizioni design

Venice Green

Gallotti&Radice

Prandina

Flatwig Studio

Catellani&Smith

Restart / Milano

Golran

Mogg

Il giardino di legno

VeniceM

Gustavo Martini

Amini

A&B Living

Paolo Castelli

Illulian

Federica Bubani

Bosa Ceramiche

Lighting collections by Penta

Zanetto

Twils

Via degli Olmi, 5
31040 Cessalto (TV)
Italy

T. +39 0421 469011 R.A.
T. +39 0421 469090 uff. comm.
T. +39 0421 469050 uff. sped.
F. +39 0421 327916

www.twils.it
info@twils.it

Twils[®]